

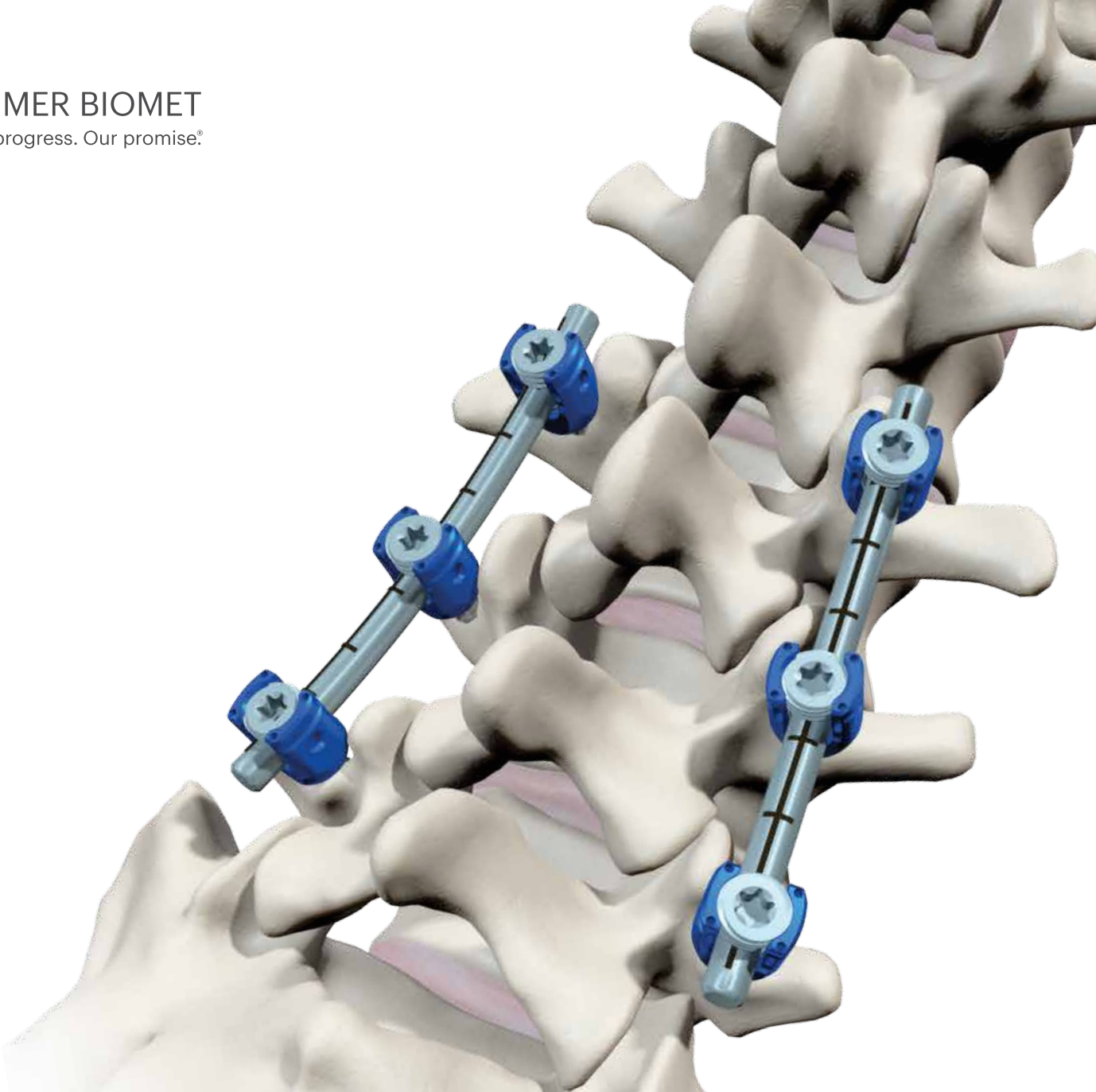

ZIMMER BIOMET
Your progress. Our promise.®



Thoracolumbar Solutions

Vital™ Spinal Fixation System

Degenerative

Surgical Technique Guide

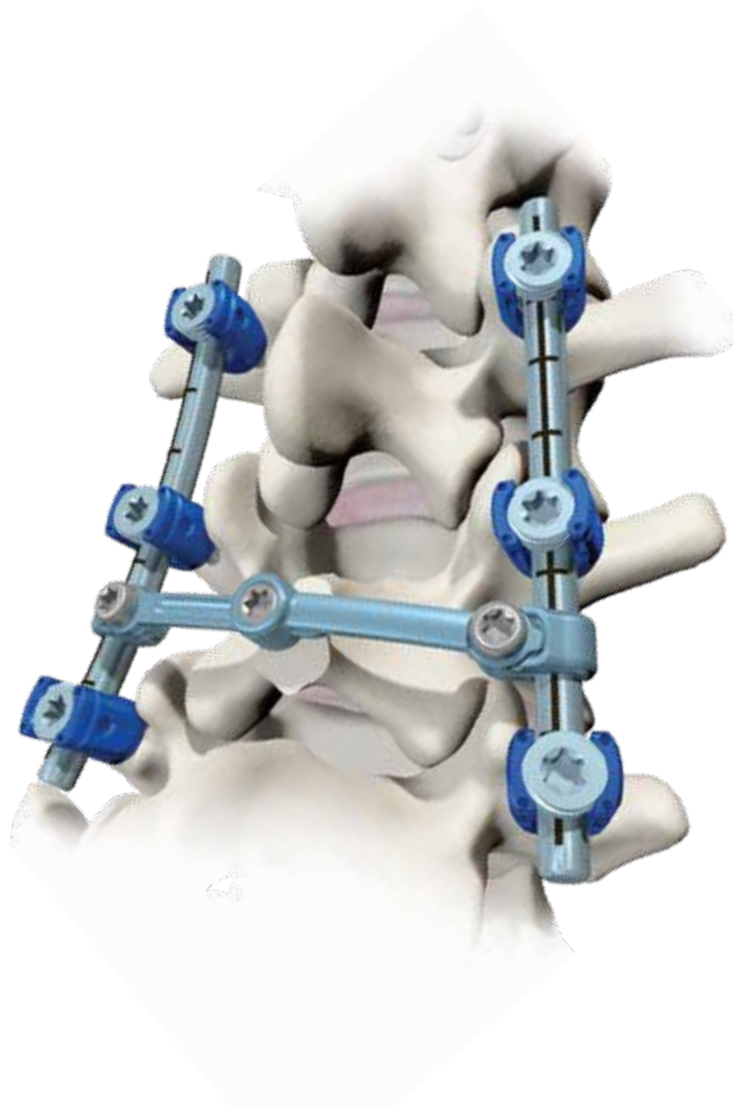

Vital Spinal Fixation System is an optimized instrument and implant kit configuration for degenerative thoracolumbar procedures.

TABLE OF CONTENTS

System Overview	4
Quick Reference Surgical Technique Guide	6
Surgical Technique	
Pedicule Preparation	8
Pedicule Screw Loading	11
Pedicule Screw Insertion	12
Rod Insertion	14
Closure Top Insertion	14
Rod Reduction	15
Compression and Distraction	24
Final Tightening	25
Transverse Connector	26
Removal or Revision	27
Kit Contents	28
Implants	29
Instruments	30
Important Information on the Vital Spinal Fixation System	31

Zimmer Biomet Spine does not practice medicine. This technique was developed in conjunction with health care professionals. This document is intended for surgeons and is not intended for laypersons. Each surgeon should exercise his or her own independent judgment in the diagnosis and treatment of an individual patient, and this information does not purport to replace the comprehensive training surgeons have received. As with all surgical procedures, the technique used in each case will depend on the surgeon's medical judgment as the best treatment for each patient. Results will vary based on health, weight, activity and other variables. Not all patients are candidates for this product and/or procedure.

VITAL SYSTEM OVERVIEW

The Vital™ Spinal Fixation System provides an optimized kit configuration solution for degenerative thoracolumbar procedures, evolved from the advanced implant and instrument features of the comprehensive Vitality® Spinal Fixation System. The minimized, two-kit configuration is an easy-to-follow color-coded tray layout tailored to potentially reduce reprocessing and sterilization costs, improve operating room efficiency and offers the potential to shorten the surgical staff's learning curve.

Features and Benefits

Optimized Instrument Kit

- Consolidates instruments and implants into only two kits, simplifying what is required for a degenerative case.
- Minimizes the OR footprint and lowers the burden on staff for sterile field set up and sterile processing, which could reduce OR costs and reduce the surgical staff's instrument learning curve.

Operational Efficiencies

Color-coded kit configuration streamlines the procedure for scrub techs and surgeons:

- Light blue—pedicle targeting/prep and screw insertion
- Gold—rod insertion and manipulation
- Green—final tightening
- Magenta—transverse connectors

Advanced Implant and Instrument Design

- Dual-lead screws and set screws are specifically designed for speed, and ease of use.
- Specially designed dual-lead thread form promotes improved screw stability and requires fewer revolutions to insert. This improves surgeon efficiency by allowing screw insertion twice as fast as comparable single lead screws without sacrificing pull-out strength.*
- **Tower Reducer** - Features a slim profile and streamlined functionality with easy secure screw engagement. The tower reducer has dual-functionality reduction options based on user preference; a quick on/off option and a fully threaded option. The tower reducer offers 30 mm of reduction capability.
- **Rocket™ Threaded Reducer** - Features spring loaded arms and a threaded barrel that provides tactile feedback, infinite adjustability for controlled reduction, and easy secure screw engagement. The rocket reducer provides simultaneous rod translation and reduction, accommodating significant medial or lateral rod offset. The rocket reducer offers 30 mm of reduction and 15 mm of medial-lateral rod translation.



Vital Instruments Kit

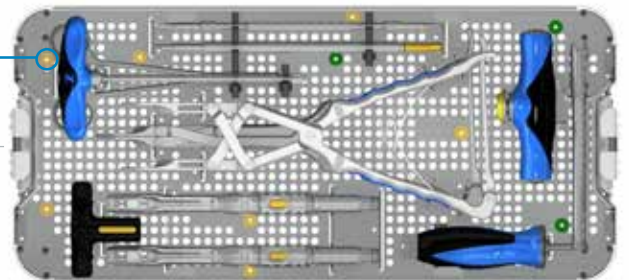

Vital Implant and Additional Instruments Kit

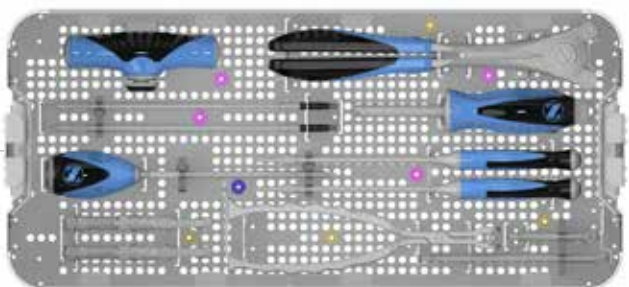
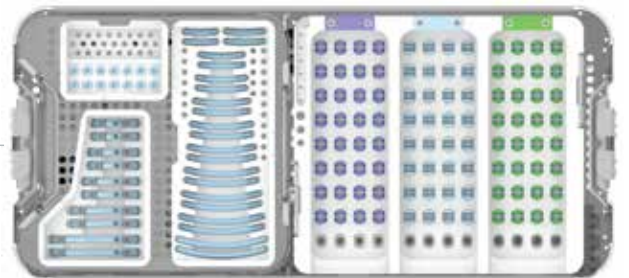

VITAL IMPLANT FEATURES

Multiple Instrument Connection Features

- The multiple screw head connection points allow various instruments to quickly and securely attach, simplifying manipulation maneuvers.

Friction Fit Screw Head

- Retains alignment, allowing for easy screw-rod orientation and ease of screw loading.
- Accommodates $\varnothing 5.5$ mm and $\varnothing 6.0$ mm rods.

Fully Threaded Dual-lead Screw Shank

- Self-tapping fully threaded blunt tip screw shank designed to improve the starting characteristics and improve bone screw fixation while reducing insertion torque.
- Improves surgeon efficiency by allowing screw insertion twice as fast as comparable single lead screws without sacrificing pull-out strength.*

T27 Hexalobe Drive Feature

- Screws and closure tops utilize T27 drive (one of largest in industry): 30% greater strength than T25 drive (MDT), 90% greater strength than T20 drive (D/S).

Dual-lead Reverse Angle Thread Closure Top

- Dual-lead reverse angle thread designed to improve engagement, advance quickly and help prevent head splay.
- Closure top design supports loosening after final tightening and re-tightening of closure top without performance loss.



Vital Implant Specifications

Major \varnothing	Minor \varnothing	Angulation (A)	Run on Rod (B)	Head Height (C)	Height Above $\varnothing 5.5$ mm Rod (D)
4.5 mm	3.0 mm	56°	9.1 mm	15 mm	3.8 mm
5.5 mm	3.6 mm	51°	9.1 mm	15 mm	3.8 mm
6.5 mm	4.5 mm	51°	9.1 mm	15 mm	3.8 mm
7.5 mm	5.18 mm	51°	9.1 mm	15 mm	3.8 mm
8.5 mm	5.9 mm	43°	9.1 mm	16.5 mm	3.8 mm

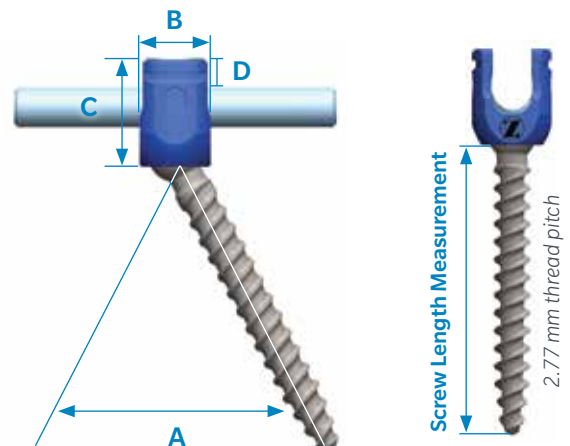

*Data on file at Zimmer Biomet (TPR#00184)

QUICK REFERENCE SURGICAL TECHNIQUE GUIDE

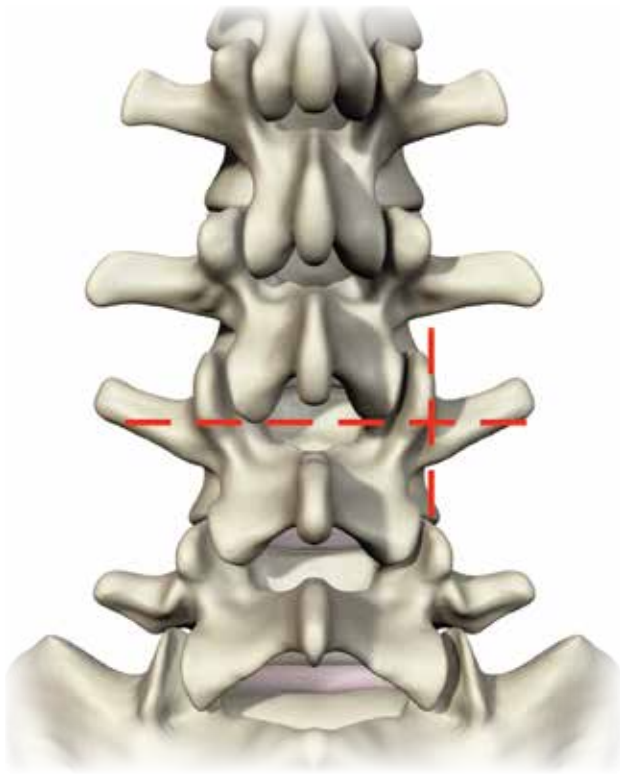

1. Pedicle Targeting



3. Screw Insertion



2. Pedicle Preparation

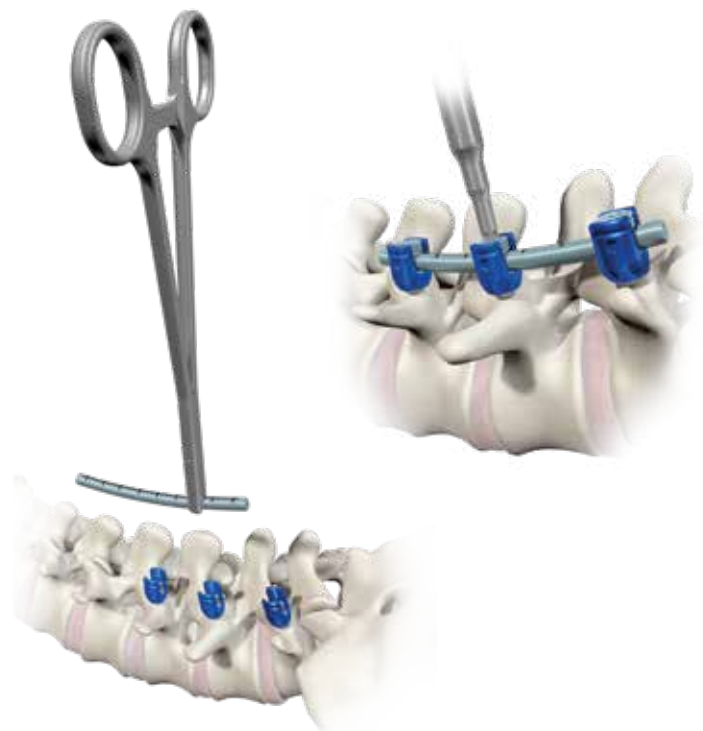

4. Rod and Closure Top Insertion



5. Manipulation (if Necessary)



6. Final Tightening

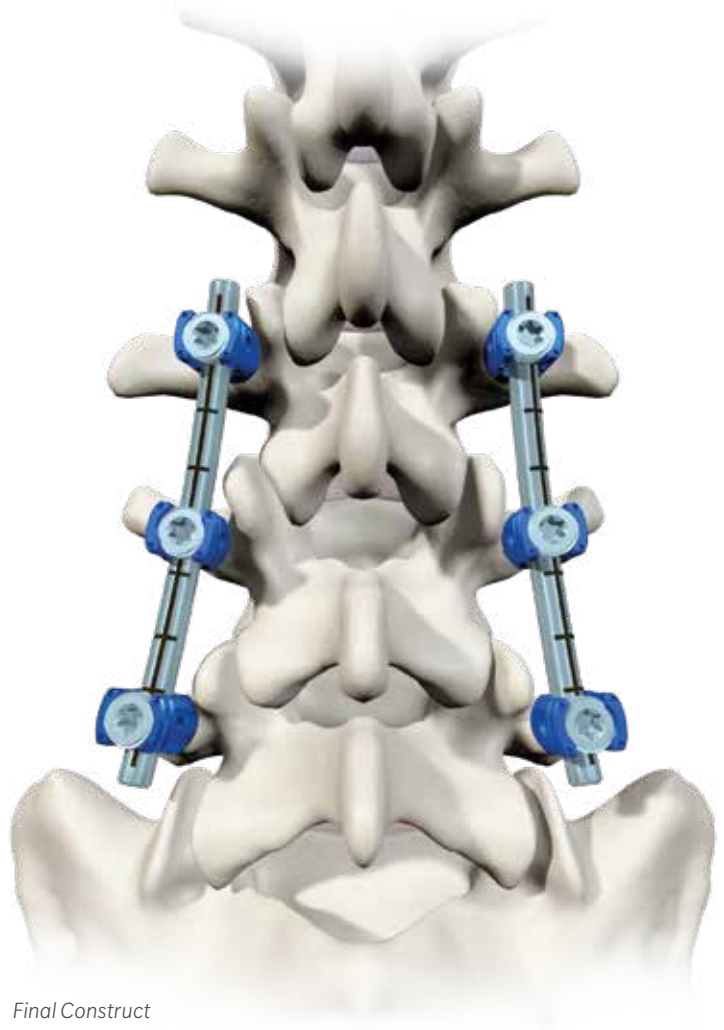

Final Construct

SURGICAL TECHNIQUE

The following Surgical Technique Guide describes the recommended placement and use of all Vital Spinal Fixation System components.

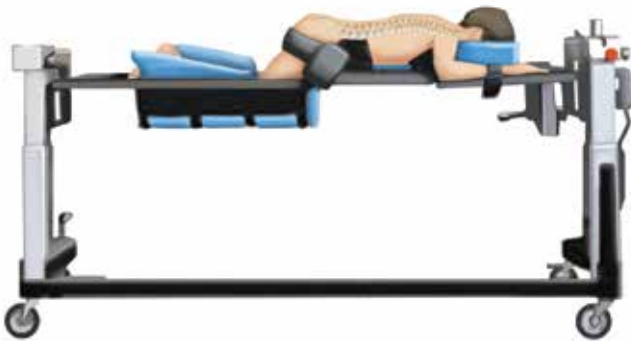

PATIENT POSITIONING

- Place the patient in the prone or knee-chest position on a radiolucent operating table. Adjust the table (as needed) so that the C-Arm provides true A/P images when at 90° and true lateral images at 0°.

PEDICLE PREPARATION

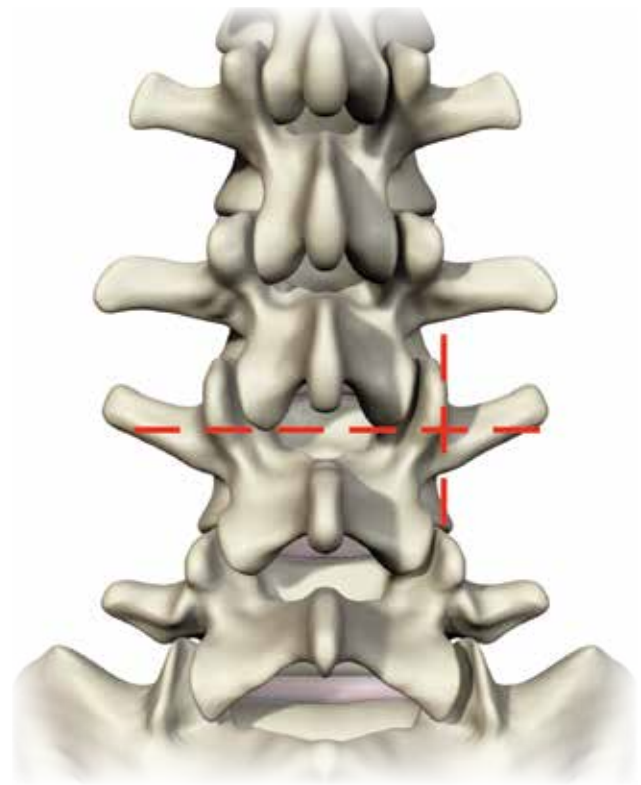

PEDICLE TARGETING

- Precise positioning of the pedicle entry point is essential. Proper orientation of the pedicle screw is dependent upon the position of the pilot hole. The pilot hole should be started where a line through the middle of the transverse process crosses a vertical line at the lateral edge of the facet joints.



PROBE

- Using the curved lenke probe, pierce the bone cortex at the entry point, making sure the curved tip is initially pointed laterally for the first 20 mm–25 mm (to avoid breaching the medial cortex).

Note: Laser markings are etched on the probe tip every 10 mm to assist with determining depth of probe.

A straight probe is available in the Vital kit, and may be used in place of the curved lenke probe, following the same pedicle trajectory.

Optional Step (Prior to Probe):

Awl

- Using the awl, pierce the bone cortex at the entry point.

Note: The lumbar bone awl creates a 4 mm wide by 10 mm deep pilot hole.

- Once the probe tip has been advanced 20 mm–25 mm, rotate the probe 180°, and continue advancing probe to desired depth.



10 mm markings



10 mm markings

Color bands on taps correspond with screw heads (i.e., 5.5 mm tap and 5.5 mm screw head are dark blue)

CONFIRM PEDICLE INTEGRITY

- After removing the pedicle probe, verify the integrity of the pedicle and the vertebral body walls using the ball tip probe. When fully inserted, a forceps can be clamped onto the ball tip probe to determine the hole depth for choosing the screw length.

Note: Laser markings are etched on probe tip every 10 mm to assist with determining depth of probe. Optional pedicle markers, for fluoroscopic visualization, are available upon request.

TAPPING

- Connect the appropriate diameter tap to the ratcheting straight handle. Insert the tap into the pedicle and rotate it clockwise. A depth gauge on the tap indicates the hole depth. Remove the tap by turning it counterclockwise.

Note: The Vital System offers taps that are true to labeled size. After removing the tap, the ball tip probe can be used again to verify the integrity of the pedicle and vertebral body walls.

PEDICLE SCREW LOADING



SCREWDRIVER LOADING

Depending on the spinal pathology being treated, a surgeon may choose to utilize different types of pedicle screws.

- 1 Connect the ratcheting straight handle to the standard screwdriver.
- 2 Place the appropriate screw on to the standard screwdriver by inserting the screwdriver tip into the female hexalobe on the screw shank, making sure the screw shank is straight.
- 3 Secure the screw by turning the standard screwdriver sleeve clockwise into the screw head.
- 4 The screwdriver sleeve may be locked by pushing the button on the secondary lock and sliding the collar downwards. This secure locking system prevents screw loosening and toggle during insertion. Confirm the collar is fully engaged and locked.

Note: The screwdriver sleeve may be used during this step. To connect, slide the sleeve over the screwdriver until it is fully engaged on the retaining feature. The sleeve must be assembled prior to loading the pedicle screw. A ratcheting T-handle and fixed handle-palm are available upon request.

PEDICLE SCREW INSERTION



SCREW INSERTION

- Insert the screw through the prepared pedicle until it reaches the desired depth.



RELEASE SCREWDRIVER

- Release the standard screwdriver by pushing the button on the screw driver lock and pulling the sleeve toward the handle. Turn the sleeve counterclockwise to loosen the screwdriver from the screw head.
- Repeat pedicle preparation and screw insertion steps for all of the screws.



SCREW ADJUSTMENT

- The head height adjuster can be used to adjust screw head alignment prior to rod insertion. To adjust screw height, fully insert the head height adjuster into the screw shank and turn to the desired height. To adjust head orientation, insert the head height adjuster into the screw head and turn to ensure screw heads are in proper orientation for rod insertion.



ROD SELECTION AND BENDING

- Surgeons should select the rod that is appropriate for their patient's needs.
- Use the french rod bender to prepare and contour the rods with progressive bends. Pre-contoured versions simplify the initial approximation.

Note: The surgeon should reference the markings on the rod to achieve contours in the desired place.

ROD INSERTION



INSERT ROD

- Use the rod holder to position the rod within the screw heads.

CLOSURE TOP INSERTION

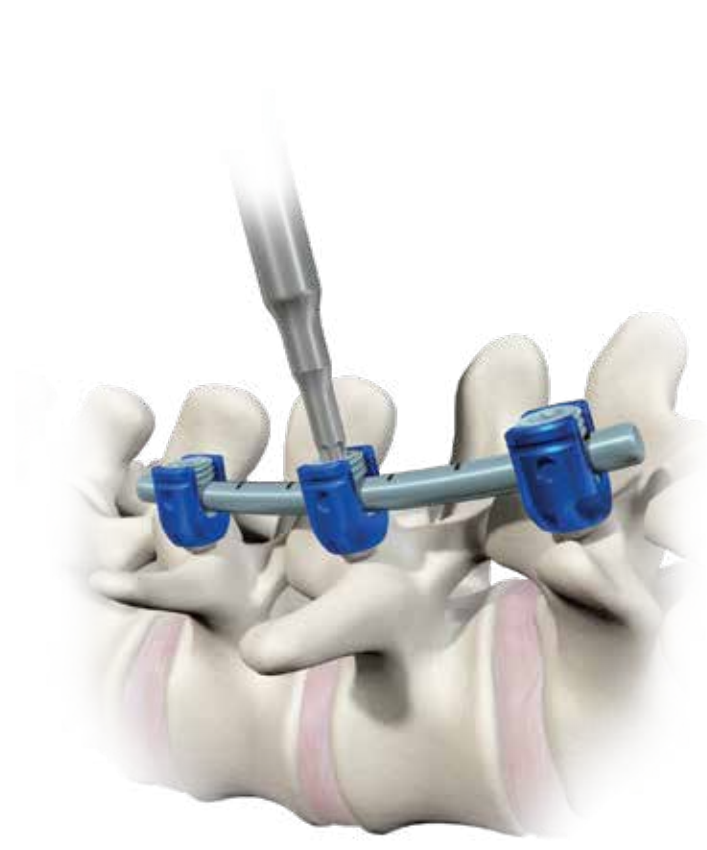

PROVISIONAL TIGHTENING

- Insert the T27 provisional driver or dual-ended closure top starter into the hexalobe drive interface of the closure top. Align the driver with the screw head and introduce the closure top. Turn the closure top until it comes into contact with the rod. Do not final tighten. Repeat this procedure for inserting all closure tops.

ROD REDUCTION

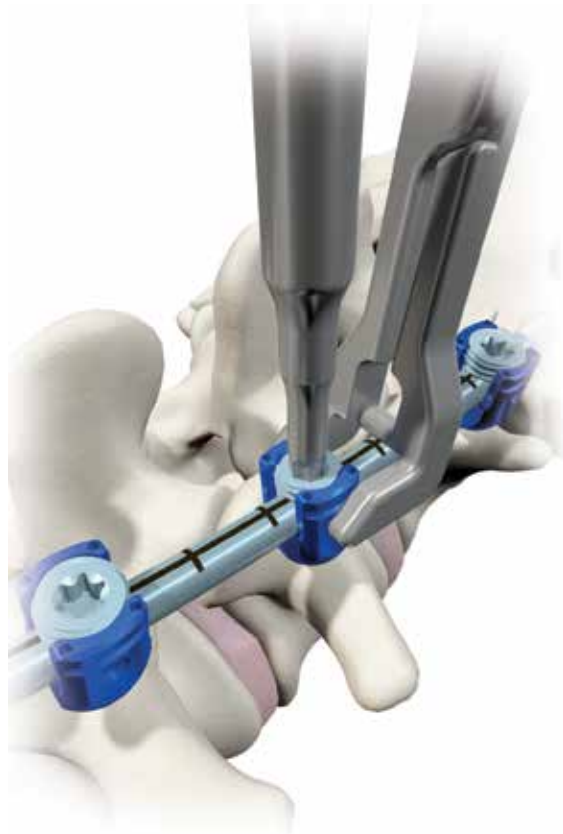

OPTION 1: ROD ROCKER

- For moderate reduction, the rod rocker may be used. Align the prongs of the rod rocker in the medial and lateral slots on the screw head. Close and lock the rod rocker and use the rod rocker as a lever to introduce the rod into the screw head.
- Once the rod is fully reduced into the screw head, use the T27 provisional driver or dual-ended closure top starter to introduce the closure top into the screw head. Turn the closure top until it comes in contact with the rod. Do not final tighten.

ROD REDUCTION (*continued*)

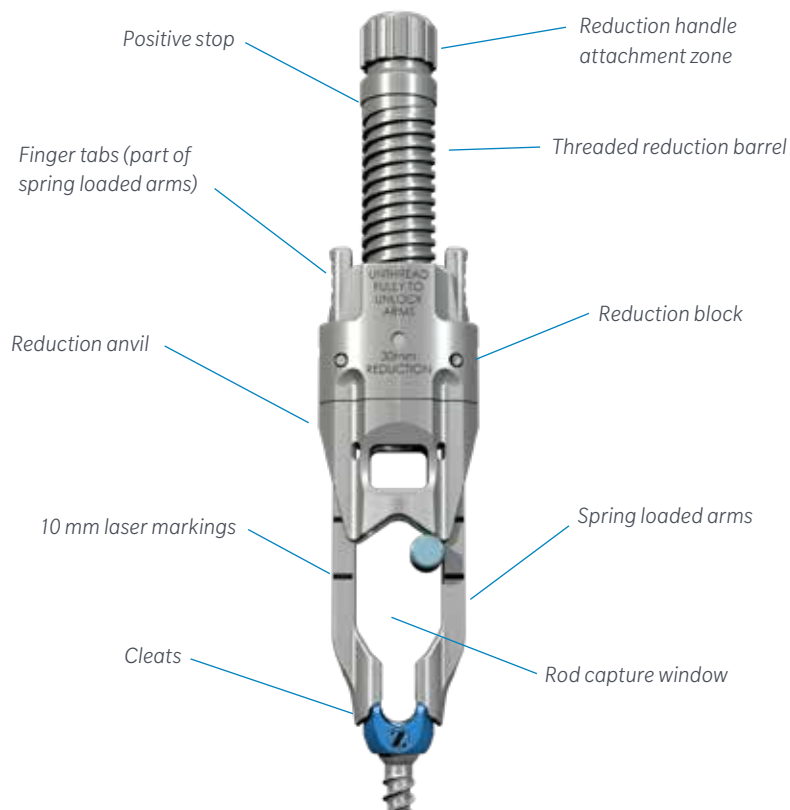

OPTION 2: ROCKET THREADED REDUCER

- The rocket reducer provides simultaneous rod translation and reduction. Its unique features aid in guiding a rod into proper position within the screw tulip.
- The rod capture window allows straightforward screw engagement while accommodating significant medial or lateral rod offset. The rocket reducer allows for 30 mm of total reduction and 15 mm of medial-lateral rod translation.

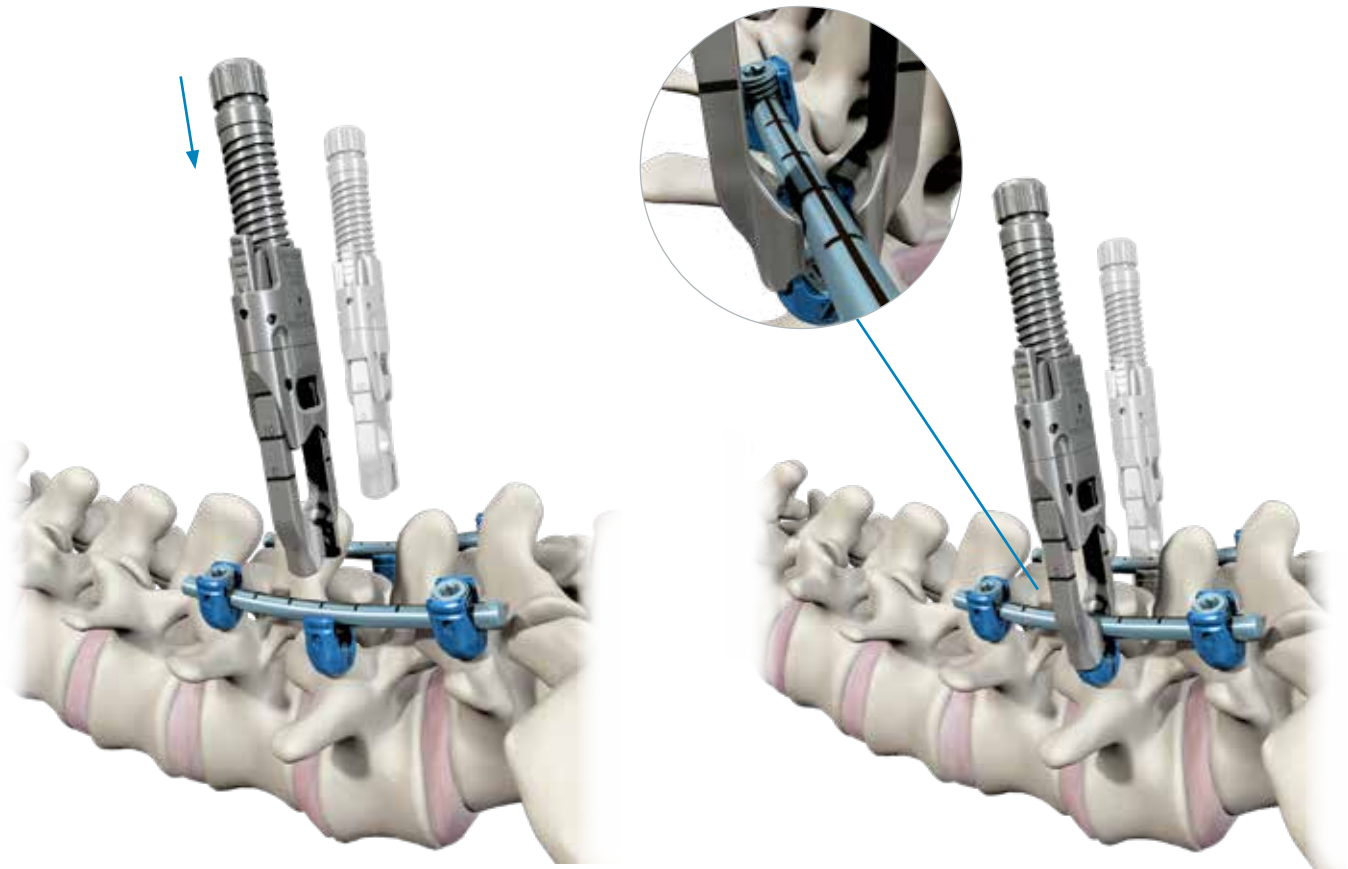

ROCKET THREADED REDUCER STEPS

- Grasp the rocket reducer by the reduction block or the threaded reduction barrel.
- To attach the rocket reducer to the Vital screw tulip head, position the spring-loaded arms on both sides of the rod and place the cleated ends of the reducer's arms over the medial-lateral walls of the screw tulip.
- Once the cleats are in position over the screw tulip head, gently press downward; the spring-loaded arms will capture the screw tulip head.
- To provisionally secure the rocket reducer to the screw tulip head, grasp the positive stop area at the proximal end of the rocket reducer's threaded reduction barrel and rotate clockwise—1/2 turn to ensure full engagement of the rocket.

Note: Alternatively, the rocket reducer can be attached by depressing the finger tabs of the spring-loaded arms and positioning it into the mating Vital screw connections.

To properly attach and remove the rocket reducer, ensure the reducer is completely unthreaded, where there is no gap between the reduction anvil and reduction block.

ROD REDUCTION (continued)

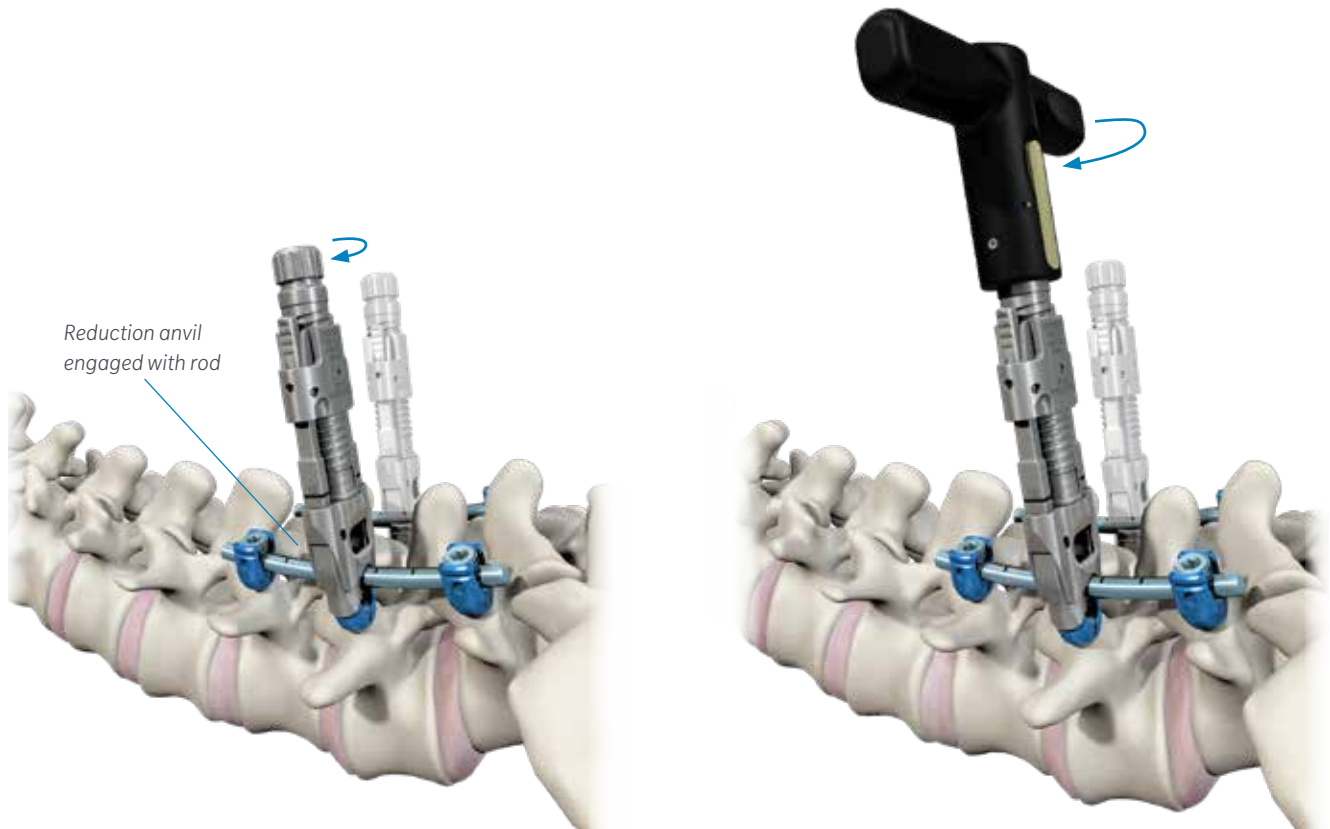

ROCKET THREADED REDUCER STEPS (continued)

- Once the desired number of rocket reducers are attached, manually rotate each rocket reducer's threaded reduction barrel clockwise until the reduction anvil engages the rod.
- Once all rocket reducers are properly attached, aligned, and their reduction anvils are contacting the rod, utilize the black reduction T-handle to sequentially reduce the screws to the rod by turning the threaded reduction barrel clockwise.
- The rod is fully reduced when the positive stop on the rocket reducer is reached, and can be confirmed by the laser markings on the spring loaded arms if visible.

Note: The short and long quick connect adapters (attached to preferred handle) can be utilized to reduce the screws to the rod.

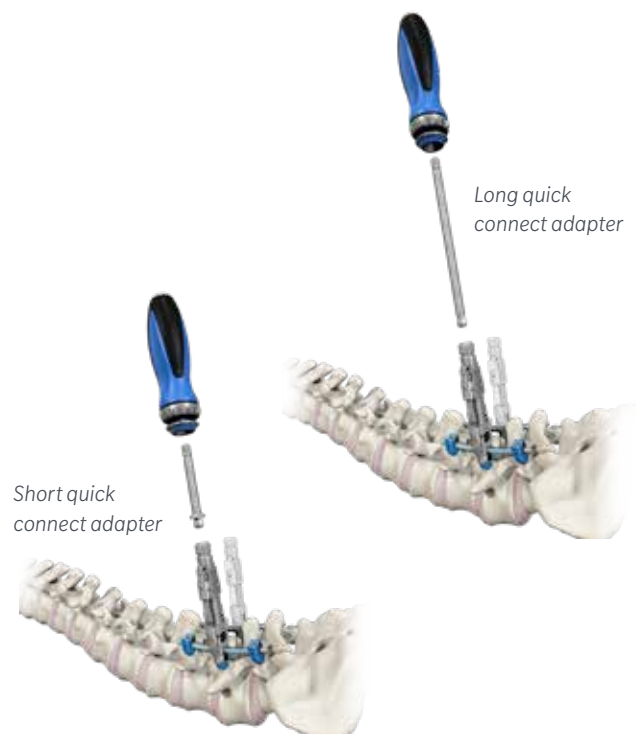

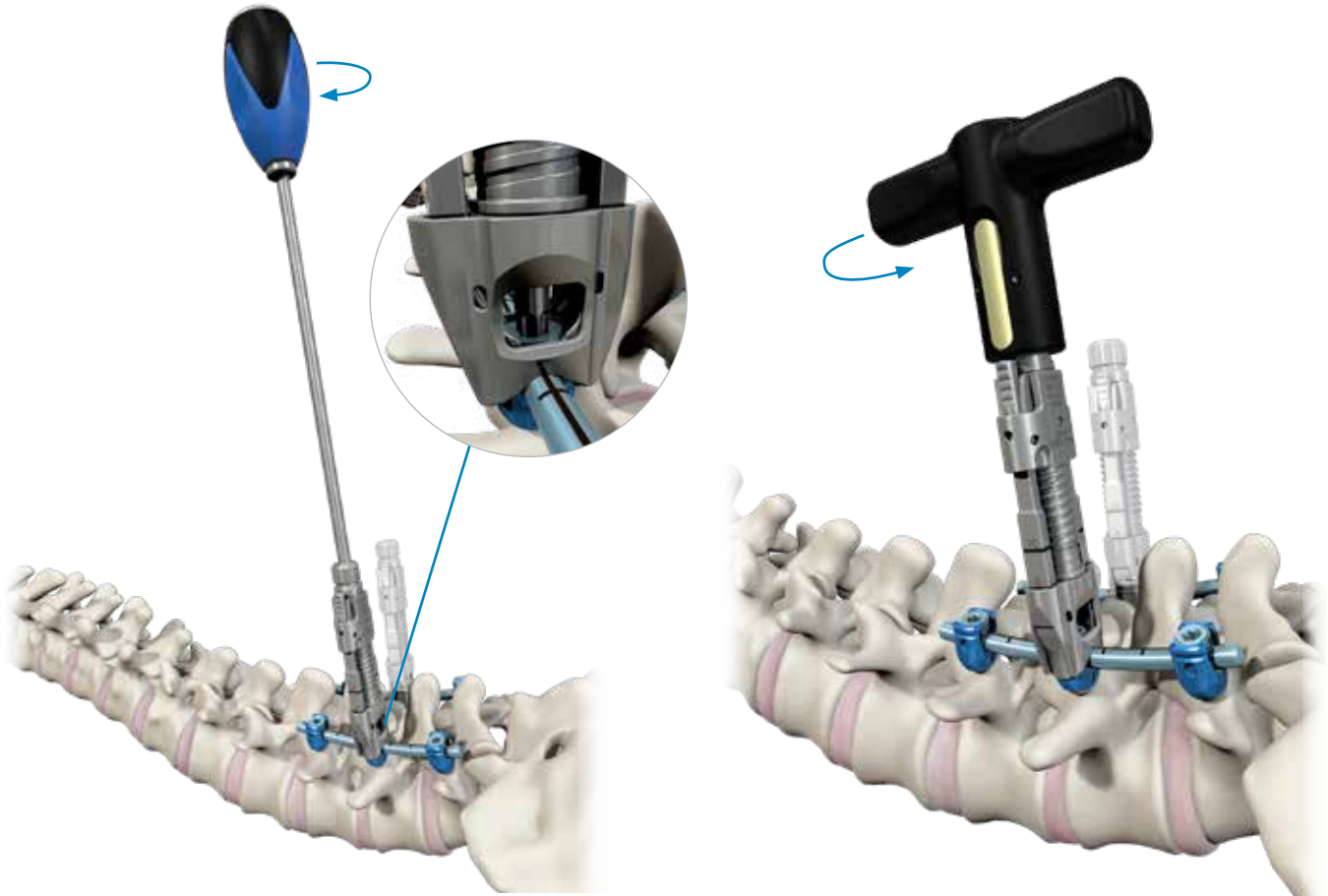

- Once the rod is fully seated in each screw head, use the T27 provisional driver to introduce the closure tops into the screw heads.
- Turn the T27 provisional driver clockwise until the closure top is fully seated in the screw tulip and holds the rod in place. Do not final tighten.
- To remove the rocket reducer, utilize the black reduction T-handle to turn the threaded reduction barrel counter-clockwise until the anvil and reduction block of the rocket meet.
- Once the rocket reducer is completely unthreaded, depress the finger tabs of the spring loaded arms and remove the rocket. Repeat until all rockets have been removed.

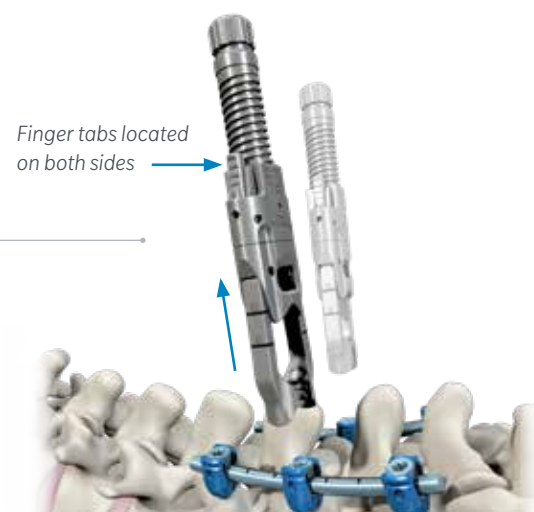

ROD REDUCTION (continued)



OPTION 3: TOWER REDUCER

The tower reducer has dual functionality that allows for two reduction options:

Quick On/Off

- Position the slide lock in the lower (down) position. The quick on/off feature captures the screw head and engages the rod more quickly. To engage more quickly, slide the outer shaft of the reducer downward until it engages the rod. Attach reducer T-handle and rotate reducer handle clockwise to reduce the rod fully into the screw head.

Note: In the quick on/off position, the reducer can be reduced in a threaded fashion by turning the reducer T-handle clockwise to engage the rod, or reduced more quickly by using the gold button to engage the rod more quickly.

Fixed (Threaded)

- Position the slide lock in the upper position (up). The fixed feature turns the tower reducer into a threaded reducer. Attach the reducer T-handle and rotate the reducer handle clockwise to reduce the outer sleeve until it engages the rod. Continue to rotate the reducer handle clockwise until the rod is fully reduced into the screw head.

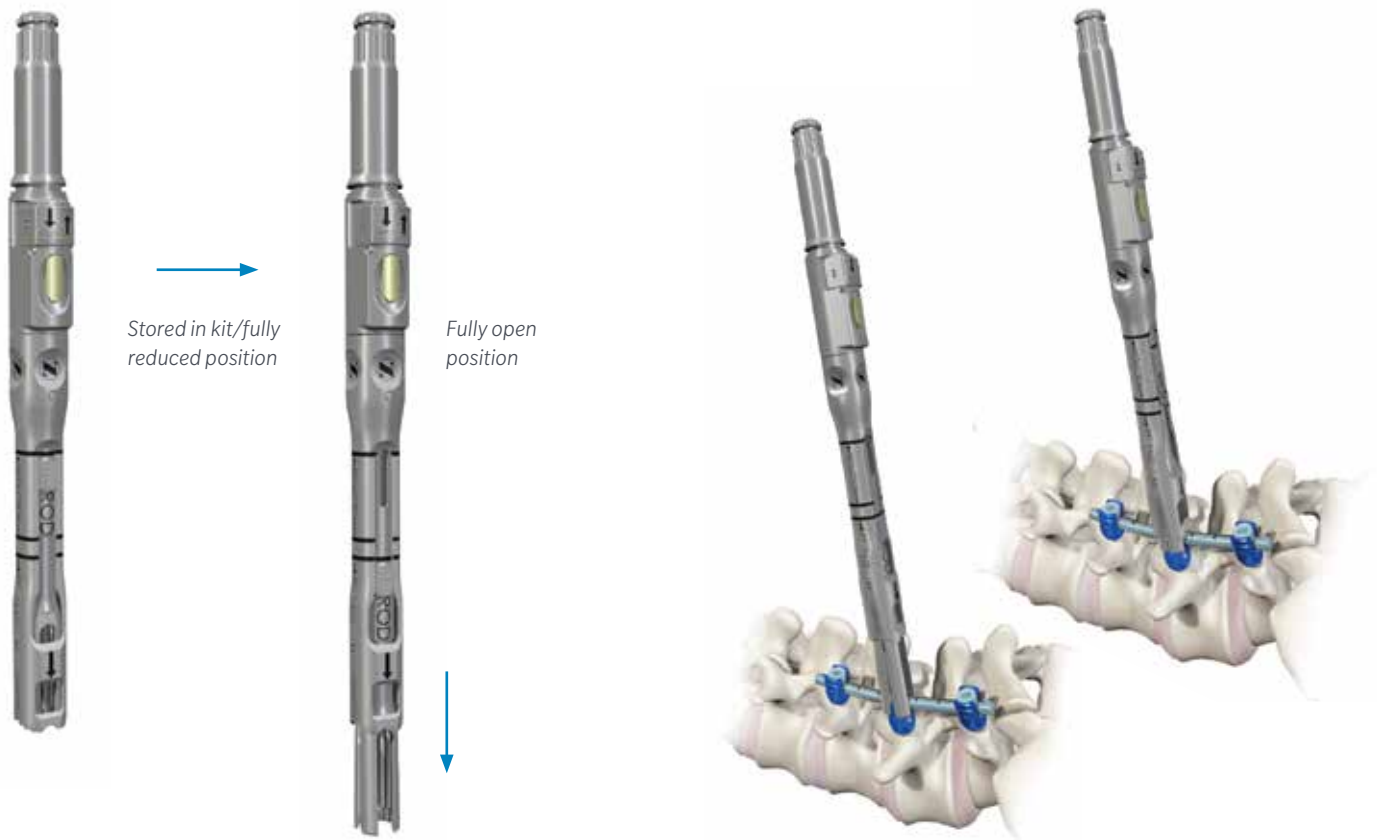

Tower Reducer Steps — Quick On/Off Option

When the rod is positioned above the screw head, the tower reducer may be used to seat the rod.

- Position the slide lock in the downward quick on/off position.
- Ensure that the tower reducer is in the fully open position by pressing and holding the gold button and using the finger serrations to fully extend the inner sleeve.
- Engage the four vertical slots cephalad and caudal by gently setting the tower reducer onto the screw head.
- Advance the tower reducer by pushing downwards until it engages the rod.

ROD REDUCTION (continued)

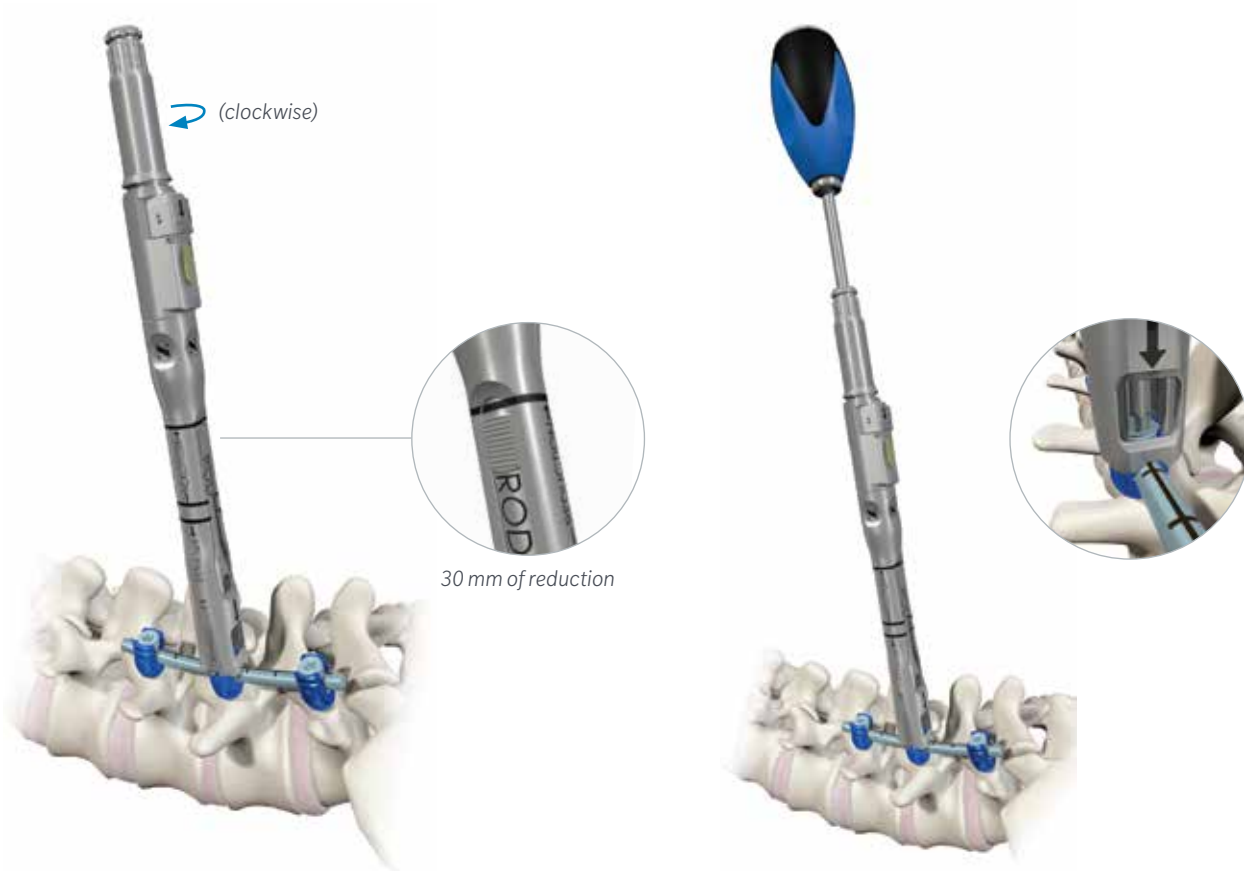

Tower Reducer Steps — Quick On/Off Option (continued)

- Rotate the top sleeve clockwise until the rod is fully reduced into the screw head. The tower reducer offers 30 mm of reduction capability.
- Confirm the rod is fully reduced by looking at the laser mark reduction lines on the outer sleeve. The inner and outer sleeve lines should match when the rod is fully reduced.

Note: For additional leverage during the reduction maneuver, attach the tower reducer T-handle to the top of the reducer by pressing the gold button and sliding over the top of tower reducer.

The short quick connect adapter (attached to preferred handle) can be utilized to reduce the screws to the rod.

- Once the rod is fully reduced into the screw head, use the T27 provisional driver to introduce the closure top into the screw head. Turn the closure top until it comes in contact with the rod. Do not final tighten.



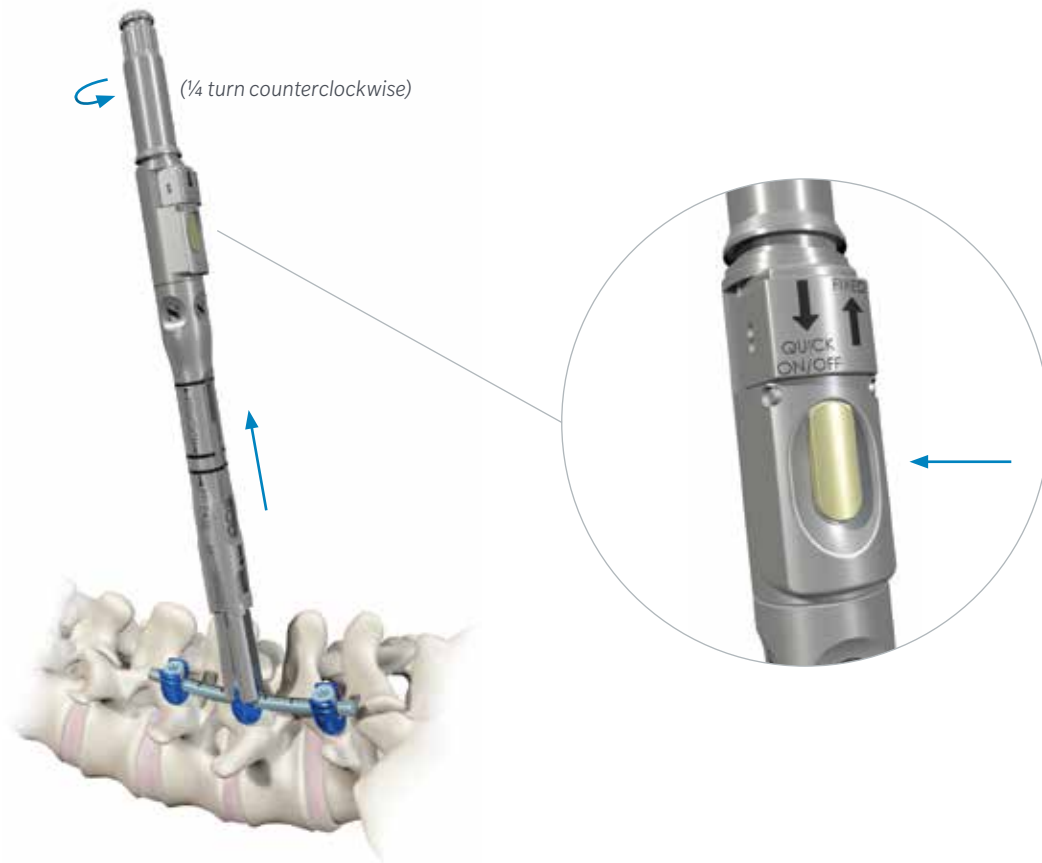

- To remove the tower reducer, turn the handle a 1/4 turn counterclockwise, push and hold the gold button at the proximal end of the reducer and gently lift the tower reducer off of the screw head.

COMPRESSION AND DISTRACTION (*if necessary*)



COMPRESSION

- To compress two screws simultaneously, place the compressor against the screws' tulip heads and squeeze the handle. Compression can also be performed sequentially by provisionally locking one screw using the T27 provisional driver and compressing off of the provisionally locked screw. When the compression maneuver is complete, provisionally lock the compressed screw and release the compressor.



DISTRACTION

- To distract two screws simultaneously, place the distractor against the screws' tulip heads and squeeze the handle. Distraction can also be performed sequentially by provisionally locking one screw using the T27 provisional driver and distracting off of the provisionally locked screw. When the distraction maneuver is complete, provisionally lock the distracted screw and release the distractor.

FINAL TIGHTENING

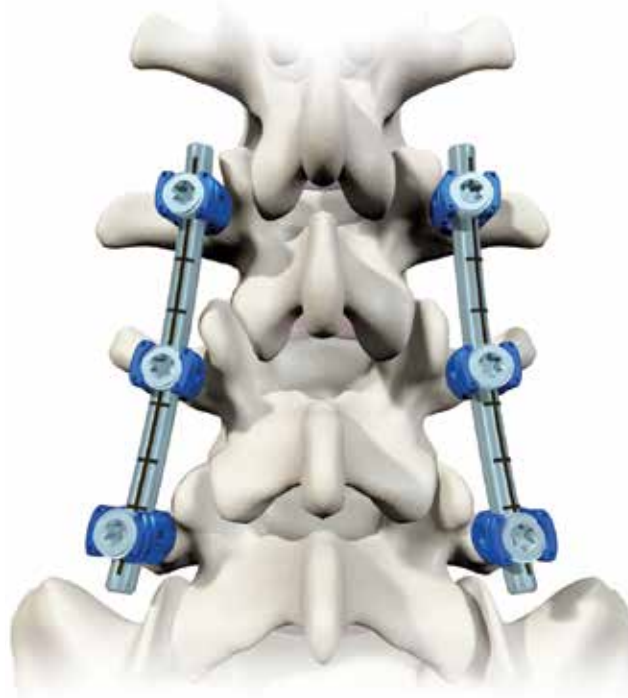

T27 FINAL TIGHTENING

- When using the torque closure top, connect the final driver to the 90 in-lbs torque limiting handle. Pass the final driver through the counter torque and insert it into the hexalobe drive interface on the closure top. While applying appropriate counter torque, turn the final closure top driver clockwise until the 90 in-lbs torque limiting handle clicks over a minimum of two times.

Note: Visually confirm the final driver tip full engagement in the closure top before sliding the counter torque over the screw head.

Note: Always use the 90 in-lbs torque limiting handle for final tightening of closure tops.

TRANSVERSE CONNECTOR (optional)

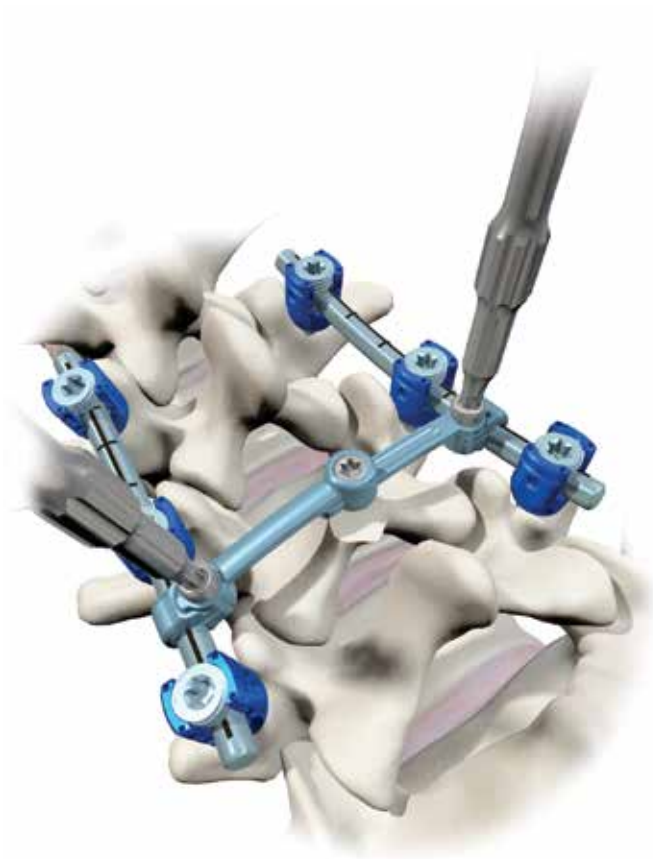

ADJUSTABLE TRANSVERSE CONNECTOR PLACEMENT

- Confirm that the center set screw is loose to allow for free range of motion prior to placing the adjustable transverse connector onto the rod construct.
- Fixate each end of the connector to each rod by pushing anteriorly on the set screw using the set screw starter.



T20 FINAL TIGHTENING

- Final lock the middle transverse connector set screw last using the same T20 final driver and torque limiting handle. Turn the T20 final driver clockwise until the 50 in-lbs torque limiting handle clicks over a minimum of two times.

Note: The transverse connector counter torque has a “Medial” marking indicating the orientation of the instrument when locking the set screws on the rod.

REMOVAL OR REVISION



REMOVE CLOSURE TOPS

- Remove the closure tops by turning the closure top counterclockwise using the T27 final closure top driver. The counter torque may be used to provide additional leverage to loosen the closure top. When all closure tops have been removed, the rod may be removed manually or by using the rod holder.



REMOVE IMPLANTED SCREW

The vital head height adjuster or the vital screwdriver can be used to remove an implanted screw.

- To remove a screw using the head height adjuster, align the head height adjuster coaxially with the shank of the screw and engage the adjuster's male hexalobe with the female hexalobe of the screw shank. Turn the head height adjuster counterclockwise to back out an implanted screw.
- To remove a screw using the vital standard screwdriver, align the driver coaxially with the shank of the screw and engage the driver's male hexalobe with the female hexalobe of the screw. Turn the outer driver sleeve clockwise to fully engage the screw head. Lock the driver sleeve by pushing on the secondary lock and sliding the collar downwards. Turn the driver counterclockwise to remove an implanted screw.

KIT CONTENTS

Vital Instruments Kit PCR700M4101

DESCRIPTION	QTY	PART NUMBER
Adult Degen/Deformity Reducer	2	730M0021
Reducer T-handle	1	730M0022
Screwdriver, Standard	2	07.02054.001
Quick Connect — Ratcheting Handle, Straight	2	07.02051.001
Rod Holder	1	07.02064.001
Head-Height Adjuster	1	07.02060.001
Pedicle Probe, Straight — Lumbar	1	730M1001
Pedicle Probe, Curved — Lumbar Lenke	1	730M1004
Tap 4.5 mm	1	730M3045
Tap 5.5 mm	1	730M3055
Tap 6.5 mm	1	730M3065
Tap 7.5 mm	1	730M3075
Ball Tip Probe — Dual-ended Stiff/Flexible	1	07.02117.001
Compressor	1	07.02089.001
Distractor	1	07.02109.001
T27 Provisional Driver	2	730M0019
Counter Torque	1	730M0016
Torque-limiting Handle, 90 in-lbs	1	07.02053.001
T27 Driver, Final	2	730M0017
Dual-ended Closure Starter	1	730M0018
Screw Driver Sleeve	2	07.02131.001

Vital 4.5 mm/8.5 mm Auxiliary Implant Caddy PCR700M4995

DESCRIPTION	QTY	PART NUMBER
ø4.5 mm × 30 mm Polyaxial Screw	4	701M4530
ø4.5 mm × 35 mm Polyaxial Screw	4	701M4535
ø4.5 mm × 40 mm Polyaxial Screw	4	701M4540
ø4.5 mm × 45 mm Polyaxial Screw	4	701M4545
ø4.5 mm × 50 mm Polyaxial Screw	4	701M4550
ø8.5 mm × 40 mm Polyaxial Screw	4	709M8540
ø8.5 mm × 45 mm Polyaxial Screw	4	709M8545
ø8.5 mm × 50 mm Polyaxial Screw	4	709M8550
ø8.5 mm × 55 mm Polyaxial Screw	4	709M8555
ø8.5 mm × 60 mm Polyaxial Screw	4	709M8560

Implant and Additional Instruments Kit PCR700M4111

DESCRIPTION	QTY	PART NUMBER
Rocket Threaded Reducer	1	730M0024
Quick Connect Adapter - Short	1	730M0023
Quick Connect Adapter - Long	1	730M0005
Rod Rocker	1	07.02093.001
Bone Awl	1	07.02076.001
French Bender	1	07.02092.001
T20 Provisional Driver	2	07.02119.001
T20 Driver, Final	2	07.02063.001
Torque Limiting Driver — 50 in-lbs	1	07.02118.001
Counter Torque — Transverse Connector	1	07.02121.001
ø5.5 mm × 35 mm Polyaxial Screw	4	701M5535
ø5.5 mm × 40 mm Polyaxial Screw	8	701M5540
ø5.5 mm × 45 mm Polyaxial Screw	8	701M5545
ø5.5 mm × 50 mm Polyaxial Screw	8	701M5550
ø5.5 mm × 55 mm Polyaxial Screw	4	701M5555
ø6.5 mm × 35 mm Polyaxial Screw	4	701M6535
ø6.5 mm × 40 mm Polyaxial Screw	8	701M6540
ø6.5 mm × 45 mm Polyaxial Screw	8	701M6545
ø6.5 mm × 50 mm Polyaxial Screw	8	701M6550
ø6.5 mm × 55 mm Polyaxial Screw	4	701M6555
ø7.5 mm × 35 mm Polyaxial Screw	4	701M7535
ø7.5 mm × 40 mm Polyaxial Screw	8	701M7540
ø7.5 mm × 45 mm Polyaxial Screw	8	701M7545
ø7.5 mm × 50 mm Polyaxial Screw	8	701M7550
ø7.5 mm × 55 mm Polyaxial Screw	4	701M7555
ø5.5 mm–6.0 mm Standard Closure Top	14	07.02010.001
ø5.5 mm × 30 mm Rod, Curved	4	07.02015.003
ø5.5 mm × 35 mm Rod, Curved	4	07.02015.004
ø5.5 mm × 40 mm Rod, Curved	4	07.02015.005
ø5.5 mm × 45 mm Rod, Curved	4	07.02015.006
ø5.5 mm × 50 mm Rod, Curved	4	07.02015.007
ø5.5 mm × 55 mm Rod, Curved	4	07.02015.008
ø5.5 mm × 60 mm Rod, Curved	4	07.02015.009
ø5.5 mm × 65 mm Rod, Curved	4	07.02015.010
ø5.5 mm × 70 mm Rod, Curved	4	07.02015.011
ø5.5 mm × 75 mm Rod, Curved	4	07.02015.012
ø5.5 mm × 80 mm Rod, Curved	4	07.02015.013
Transverse Connector, Adjustable		
33 mm–36 mm Wide × 5.5 mm	2	07.02030.001
36 mm–41 mm Wide × 5.5 mm	2	07.02030.002
41 mm–51 mm Wide × 5.5 mm	2	07.02030.003
51 mm–70 mm Wide × 5.5 mm	2	07.02030.004
70 mm–90 mm Wide × 5.5 mm	2	07.02030.005

IMPLANTS

Screws



Polyaxial Screws

- 4.5 mm (Magenta)
- 5.5 mm (Dark Blue)
- 6.5 mm (Light Blue)
- 7.5 mm (Green)
- 8.5 mm (Gold)

Rod



ø5.5 mm Ti Curved Rods

- 30 mm–80 mm

Closure Top



Closure Top — Torque Limiting

PART NUMBER

07.02010.001

Transverse Connectors



Adjustable Transverse Connector — 5.5 mm

PART NUMBER

33 mm–36 mm

07.02030.001

36 mm–41 mm

07.02030.002

41 mm–51 mm

07.02030.003

51 mm–70 mm

07.02030.004

70 mm–90 mm

07.02030.005

INSTRUMENTS

Pedicle Preparation



Awl	PART NUMBER
	07.02076.001



Taps	PART NUMBER
4.5 mm (Magenta)	730M3045
5.5 mm (Dark Blue)	730M3055
6.5 mm (Light Blue)	730M3065
7.5 mm (Green)	730M3075



Ratcheting Straight Handle	PART NUMBER
	07.02051.001



Pedicle Probes — Lumbar	PART NUMBER
Straight	730M1001
Curved Lenke	730M1004



Ball Tip Probe — Dual-ended	PART NUMBER
Standard	07.02117.001

Screw Insertion



Screwdriver	PART NUMBER
	07.02054.001



Screwdriver Sleeve	PART NUMBER
Standard	07.02131.001

Rod and Closure Top Insertion



Head Height Adjuster	PART NUMBER
	07.02060.001



French Rod Bender	PART NUMBER
	07.02060.001



T27 Provisional Driver — Reducer (Long)	PART NUMBER
	730M0019

Rod and Closure Top Insertion (Continued)



Rod Holder PART NUMBER
07.02064.001



T27 Provisional Driver — Dual-ended PART NUMBER
730M0018

Compression/Distraction



Compressor PART NUMBER
07.02089.001



Distractor PART NUMBER
07.02109.001

Rod Reduction



Tower Reducer PART NUMBER
730M0021



Tower Reducer T-handle PART NUMBER
730M0022



Rod Rocker PART NUMBER
07.02093.001



Rocket Threaded Reducer PART NUMBER
730M0024



Quick Connect Adapter – Short PART NUMBER
730M0023



Quick Connect Adapter – Long PART NUMBER
730M0005

INSTRUMENTS *(continued)*

Final Tightening



T27 Final Driver	PART NUMBER
	730M0017



Torque-limiting Handle 90 in-lbs	PART NUMBER
	07.02053.001



Counter Torque	PART NUMBER
	730M0016

Transverse Connector Insertion/Final Tightening



T20 Provisional Driver	PART NUMBER
	07.02119.001



T20 Final Driver	PART NUMBER
	07.02063.001



Torque-limiting Handle 50 in-lbs	PART NUMBER
	07.02118.001



Counter Torque — Transverse Connector	PART NUMBER
	07.02121.001

IMPORTANT INFORMATION ON THE VITAL SPINAL FIXATION SYSTEM

Vital

The Vital Spinal Fixation System is a subsystem of the Vitality Spinal Fixation System.

Device Description

The Vitality Spinal Fixation System is a thoracolumbar and sacroiliac fixation system designed to aid in the surgical correction of several types of spinal conditions. The system consists of a variety of spinal rods, pedicle screws, hooks and connectors intended only to provide temporary stabilization during the development of a solid fusion of the spine with bone graft. The system can be rigidly locked into a variety of configurations, with each construct being customized to the patient's anatomy. All implants are single use only and should not be reused under any circumstances. The implant system is intended to be removed after solid fusion has occurred.

The system also includes instrumentation for insertion, securing and removal of the implants. All implants are made from medical grade titanium alloy; select rods are also available in medical grade cobalt chromium alloy. Implants made from medical grade titanium, medical grade titanium alloy, and medical grade cobalt chromium may be used together. Never use titanium, titanium alloy and/or cobalt chromium with stainless steel in the same implant construct. The Vitality Spinal Fixation System is compatible with components from other cleared spinal fixation systems. See Indications below.

Indications

The Vitality Spinal Fixation System implants are non-cervical spinal fixation devices intended for posterior pedicle screw fixation (T1 S2/ilium), posterior hook fixation (T1 L5), or anterolateral fixation (T8 L5). Pedicle screw fixation is indicated for skeletally mature patients and for adolescent patients.

These devices are indicated as an adjunct to fusion for all of the following indications: degenerative disc disease (defined as discogenic back pain with degeneration of the disc confirmed by history and radiographic studies), spondylolisthesis, trauma (i.e., fracture or dislocation), deformities or curvatures (i.e., scoliosis, kyphosis and/or lordosis, Scheuermann's Disease), tumor, stenosis, pseudoarthrosis and/or failed previous fusion. When used as an adjunct to fusion, the Vitality Spinal Fixation System is intended to be used with autograft and/or allograft.

In addition the Vitality Spinal Fixation System is intended for treatment of severe spondylolisthesis (Grade 3 and 4) of the L5–S1 vertebra in skeletally mature patients receiving fusion by autogenous bone graft, having implants attached to the lumbosacral spine and or ilium with removal of the implant

after attainment of a solid fusion. Levels of pedicle screw fixation for these patients are L3-sacrum/ilium.

When used for posterior non-cervical pedicle screw fixation in pediatric patients, the Vitality System implants are indicated as an adjunct to fusion to treat adolescent idiopathic scoliosis. The Vitality System is intended to be used with autograft and/or allograft. Pediatric pedicle screw fixation is limited to a posterior approach.

The use of the Vitality Spinal Fixation System in skeletally mature patients may include the fixation of the Instinct® Java™ Spinal Fixation System* hooks, APEX Spinal System™* hooks, or fixation of the Universal Clamp® Spinal Fixation System* to the rods of the Vitality Spinal Fixation System. The Vitality Spinal Fixation System may also be used in skeletally immature patients when connected with the Universal Clamp Spinal Fixation System.

In order to achieve additional levels of fixation in skeletally mature patients, the Vitality Spinal Fixation System may be connected to the Virage® OCT Spinal Fixation System* and the Instinct Java Spinal Fixation System offered by Zimmer Biomet Spine, using rod connectors.

Contraindications

The Vitality System is not designed or sold for any use except as indicated. **DO NOT USE THE VITALITY SYSTEM IMPLANTS IN THE PRESENCE OF ANY CONTRAINDICATION.**

- Insufficient bone quantity, severe osteoporosis or other condition that might compromise rigid fixation of the device.
- A history of infection, active systemic infection or infection localized to the site of the proposed implantation.
- Suspected or documented metal allergy or intolerance.
- A disorder affecting the normal process of bone remodeling, including but not limited to severe osteoporosis involving the spine, excessive bone reabsorption, osteopenia, a primary or metastatic tumor involving the spine or certain metabolic disorders of osteogenesis.
- Iliac screws and offset connectors should not be used in cases of tumor or trauma of the sacrum, when additional screw fixation in S1 is not possible.
- Other relative contraindications include obesity, pregnancy, certain degenerative diseases, and foreign body sensitivity. In addition, the patient's occupation or activity level or mental capacity may be relative contraindications to this surgery. Specifically, some patients may, because of their occupation or lifestyle, or because of conditions such as mental illness, alcoholism or drug abuse, place undue stresses on the implant

* These optional components are not approved in all regions.

IMPORTANT INFORMATION ON THE VITAL SPINAL FIXATION SYSTEM *(continued)*

Warnings and Precautions

Following are specific warnings, precautions and adverse effects associated with use of the Vitality System that should be understood by the surgeon and explained to the patients. General surgical risk should be explained to the patients prior to surgery.

- Implantation of the Vitality System should be performed only by experienced spinal surgeons.
- All implants are intended for single use only. Single-use devices should not be re-used. Possible risks associated with re-use of single-use devices include:
 - Mechanical malfunction
 - Transmission of infectious agents
- Metal sensitivity has been reported following exposure to orthopedic implants. The most common metallic sensitivities (nickel, cobalt and chromium) are present in medical grade stainless steel and cobalt-chrome alloys.
- Universal precautions should be observed by all end users that work with contaminated or potentially contaminated medical devices. Caution should be exercised when handling devices with sharp points or cutting edges to prevent injuries during and after surgical procedures and reprocessing.
- Warning: The safety and effectiveness of pedicle screw spinal systems have been established only for spinal conditions with significant mechanical instability or deformity requiring fusion with instrumentation. These conditions are significant mechanical instability or deformity of the thoracic, lumbar and sacral spine secondary to severe spondylolisthesis (grades 3 and 4) of the L5–S1 vertebra, degenerative spondylolisthesis with objective evidence of neurological impairment, fracture, dislocation, scoliosis, kyphosis, spinal tumor and failed previous fusion (pseudoarthrosis). The safety and effectiveness of these devices for any other conditions are unknown.
- Warning: The safety and effectiveness of this device has not been established for use as part of a growing rod construct. The device is only intended to be used when definitive fusion is being performed at all instrumented levels.
- Additional Warnings for Pediatric Patients: The use of pedicle screw fixation in the pediatric population may present additional risks when patients are of smaller stature and skeletally immature. Pediatric patients may have smaller spinal structures (pedicle diameter or length) that may preclude the use of pedicle screws or increase the risk of pedicle screw malpositioning and neurological or vascular injury. Patients who are not skeletally mature undergoing spinal fusion procedures may have reduced longitudinal spinal growth, or may be at risk for rotational spinal deformities (the “crankshaft phenomenon”) due to continued differential growth of the anterior spine.
- Precaution: The implantation of pedicle screw spinal systems should be performed only by experienced spinal surgeons with specific training in the use of this pedicle screw spinal system because this is a technically demanding procedure presenting a risk of serious injury to the patient.
- Additional Precautions for Pediatric Patients: The implantation of pedicle screw spinal systems in pediatric patients should be performed only by experienced spinal surgeons with specific training in the use of this pedicle screw spinal system in pediatric patients because this is a technically demanding procedure presenting a risk of serious injury to the patient.

Preoperative and operating procedures, including knowledge of surgical techniques, good reduction, and proper selection and placement of the implants are important considerations in the successful utilization of the system in pediatric patients. The selection of the proper size, shape and design of the implant for each patient is crucial to the safe use of this device in pediatric patients.

Additional preoperative, intraoperative and postoperative warnings and precautions:

Preoperative

- Usage of automated cleaning processes without supplemental manual cleaning may not result in adequate cleaning of instruments.
- Proper handling, decontamination (including pre-rinsing, washing, rinsing and sterilization), storage and utilization are important for the long and useful life of all surgical instruments. Even with correct use, care and maintenance, they should not be expected to last indefinitely. This is especially true for cutting instruments (e.g., bone awls/drills) and driving instruments (e.g., drivers). These items are often subjected to high loads and/or impact forces. Under such conditions, breakage can occur, particularly when the item is corroded, damaged, nicked or scratched.
- Never use titanium, titanium alloy, and/or cobalt chromium with stainless steel in the same implant construct; otherwise, galvanic corrosion may occur.
- Zimmer Biomet does not specify the maximum number of times a re-usable instrument may be re-used. The useful life of these instruments is highly dependent on a number of factors including the frequency and manner in which they are used and the handling they experience in between uses. Inspection and, where appropriate, functional testing prior to using, is the best way to determine whether or not an individual device should be used.

Intraoperative

- If contouring of the implant is necessary for optimal fit, the contouring should be gradual and avoid any notching or scratching of the implant surface. Do not repeatedly or excessively bend the implant. Do not reverse bend the rods.
- Pedicle bone integrity should be verified.
- Care should be taken during pedicle preparation to avoid penetrating too deep.
- Care should be taken during bone preparation to avoid damage to the pedicle and to the surgical instruments.
- Care should be taken to minimize soft tissue damage during surgery.
- Care should be taken to avoid removing excess material from the lamina.
- Care should be taken to avoid cross-threading screws and closure tops.
- If any implant or instrument comes in contact with a non-sterile surface it should not be used.

Postoperative

- Adequately instruct the patient. Postoperative care and the patient's ability and willingness to follow instructions are one of the most important aspects of successful bone healing. The patient must be made aware of the limitations of the implant and that physical activity and full weight bearing have been implicated in fracture. The patient should understand that an implant is not as strong as normal, healthy bone and will fracture if excessive demands are placed on it in the absence of complete bone healing. An active, debilitated, or demented patient who cannot properly use weight-supporting devices may be particularly at risk during postoperative rehabilitation.
- The Vitality System is a temporary internal fixation device. Internal fixation devices are designed to stabilize the operative site during the normal healing process. After healing occurs, these devices serve no functional purpose and should be removed. Implant removal should be followed by adequate postoperative management to avoid fracture or refracture.

Adverse Effects

Complications and adverse reactions have been reported with the use of similar spinal instrumentation systems. These adverse effects, including the possibility of death, should be discussed with the patient prior to surgery.

- Non-union, delayed union
- Bending or fracture of implant. Fraying, kinking, loosening, bending or breaking of any or all implant components.

- Loosening of or migration of the implant
- Metal sensitivity or allergic reaction to a foreign body
- Infection
- Decrease in bone density due to stress shielding
- Pain, discomfort, or abnormal sensations due to the presence of the device
- Loss of the natural curvature of the spine
- Modification of the spinal geometric corrections of the vertebral and/or intervertebral height and/or of the reduction in spinal deformities
- Vascular and/or nerve damage due to surgical trauma or presence of the device.
- Neurological difficulties including bowel and/or bladder dysfunction, impotence, retrograde ejaculation and paraesthesia.
- Bursitis
- Dural leak
- Paralysis
- Death
- Erosion of blood vessels due to the proximity of the device, leading to hemorrhage and/or death
- Additional surgery may be required to correct any of these potential adverse effects
 - Additional Potential Adverse Effects for Pediatric Patients:
 - Inability to use pedicle screw fixation due to anatomic limitations (pedicle dimensions, distorted anatomy)
 - Pedicle screw malpositioning, with or without neurological or vascular injury
 - Proximal or distal junctional kyphosis
 - Pancreatitis

Other adverse events related to pedicle screw fixation, such as screw or rod bending, breakage, or loosening, may also occur in pediatric patients and pediatric patients may be at increased risk for device-related injury because of their smaller stature.

Disclaimer: This document is intended exclusively for physicians and is not intended for laypersons. Information on the products and procedures contained in this document is of a general nature and does not represent and does not constitute medical advice or recommendations. Because this information does not purport to constitute any diagnostic or therapeutic statement with regard to any individual medical case, each patient must be examined and advised individually, and this document does not replace the need for such examination and/or advice in whole or in part.



Caution: Federal (USA) law restricts this device to sale by or on the order of a physician. Rx only. Please refer to the package inserts for important product information, including, but not limited to, indications, contraindications, warnings, precautions, adverse effects, and patient counseling information.

eLabeling: The Instructions for Use can be accessed online by visiting the website and using the KEY-CODE provided on the product label and as shown below. Additional translations are also available in electronic format for download. To request a paper copy of the Instructions for Use, contact Zimmer Biomet Spine at the phone number provided.



Consult Instructions for Use on this website:

<http://IFU.zimmer.com>
Key-Code: 07.02199.001



Manufactured by:
Zimmer Biomet Spine, Inc.
10225 Westmoor Dr.
Westminster, CO 80021 USA
+1 800.447.3625



Zimmer GmbH
Sulzerallee 8
CH-8404 Winterthur
Switzerland
+41 058.854.80.00



ZIMMER BIOMET
Your progress. Our promise.®

800.447.3625/zimmerbiomet.com

©2018 Zimmer Biomet Spine, Inc. All rights reserved.

All content herein is protected by copyright, trademarks and other intellectual property rights, as applicable, owned by or licensed to Zimmer Biomet Spine, Inc. or its affiliates unless otherwise indicated, and must not be redistributed, duplicated or disclosed, in whole or in part, without the express written consent of Zimmer Biomet Spine. This material is intended for health care professionals, the Zimmer Biomet Spine sales force and authorized representatives. Distribution to any other recipient is prohibited.

APEX Spinal System™ is a trademark of SpineCraft, LLC.

1261.4-GLBL-en-REV0718