



Efficient. Flexible.  
Genuine.



# GenTek®

## Genuine Restorative Components

Certain®, External Hex, and T3® PRO



 **ZimVie**



# GenTek Genuine Restorative Components

Premium implants deserve premium prosthetic components. For long-term clinical success, it is essential that the interface between the implant and abutment are designed to work together. This is required to ensure a robust and stable interface that aims at delivering the long-term aesthetic and physical integrity that patients demand.

The GenTek Restorative Components are the solution for anyone who uses genuine ZimVie Dental Implants. As part of an open digital workflow, the genuine connection Ti-Bases<sup>1</sup> and Titanium Pre-Milled Abutment Blanks are aimed at ensuring the highest product quality and a precise fit through the integration of proven ZimVie Dental technologies. GenTek Restorative Components are available for ZimVie Dental Implant Systems: Certain, External Hex, and T3 PRO.





**GenTek<sup>®</sup>**

Components

ZimVie.com

### Features and Benefits

- Genuine connection components are designed and manufactured to minimize the micro-gaps and micro-movement for a robust and stable interface between the implant and abutment.
- GenTek Ti-Bases, Titanium Pre-Milled Abutment Blanks, and accessories are part of a complete and open digital workflow.
- Genuine connection Ti-Bases are compatible with CEREC<sup>®</sup> blocks, and aim to meet your Sirona<sup>®</sup> chairside workflow needs.



<sup>1</sup> Ti-Base also referenced as TiBase



# GenTek Angulated Screw Channel Ti-Bases

## Get restorative flexibility, efficiency, and strength

The genuine connection Ti-Base with angled screw channel provides access for ZimVie Dental's Implant Systems, Certain and T3 PRO, with multiple collar heights.

**Achieve efficiency to your CAD/CAM restoration workflow with a singular Ti-Base that provides flexibility of channel angulation, collar heights, and adjustable post height options.** A genuine connection Ti-Base provides the performance you expect through ZimVie Dental's proven SureSeal® Technologies when mated with a ZimVie Dental Implant.

## Anti-rotation feature

Three continuous anti-rotation notches over the entire length of the post ensures better centering and greatly reduces rotational movement of the crown to Ti-Base.

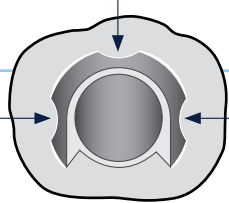

## Retention grooves

For simplified cementation



## Non-engaging Ti-Bases for bridges

GenTek Angulated Screw Channel Ti-Bases are also available for bridges. The non-engaging connection allows for the freedom of rotation ideal for making bridges.

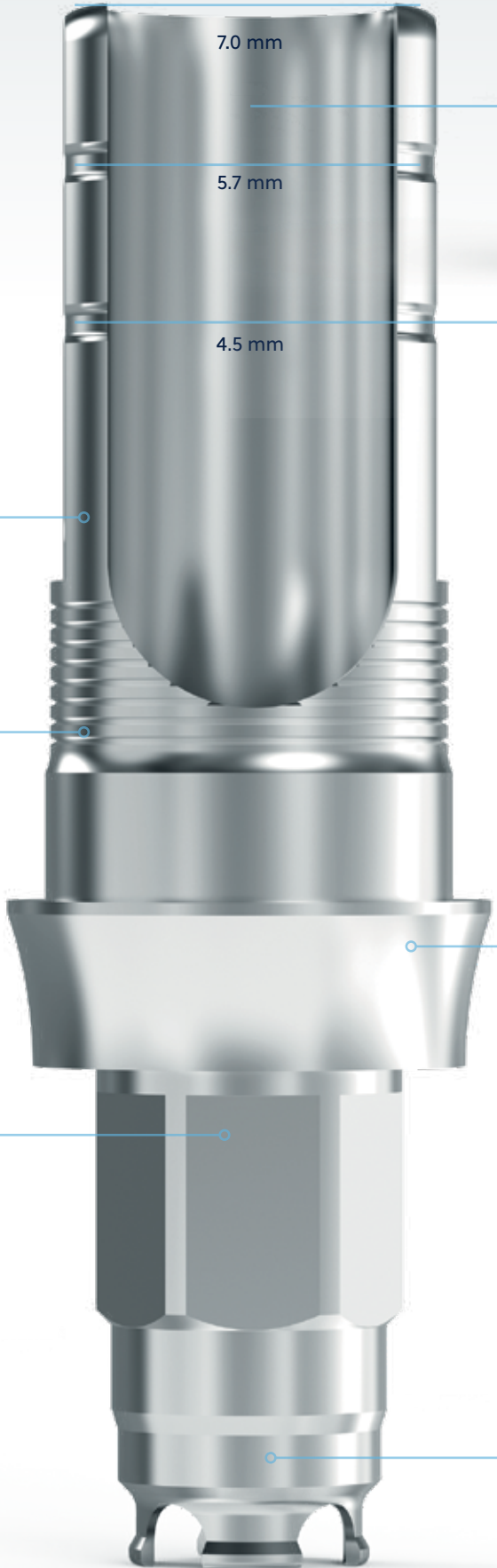



### Enabled angles for versatility<sup>1</sup>

Position the angled screw channel anywhere from 0 to 25° for improved aesthetics in anterior cases and for better access in challenging inter-arch spaces.

### Flexible post height for the body

A singular Ti-Base provides various post height options for individualized solutions.

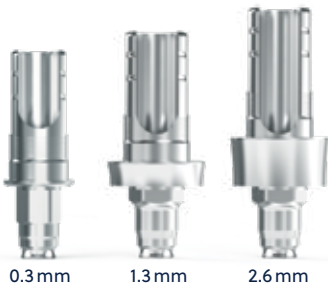

### Additional collar heights

### Connections

Available for ZimVie Dental's Implant connections.

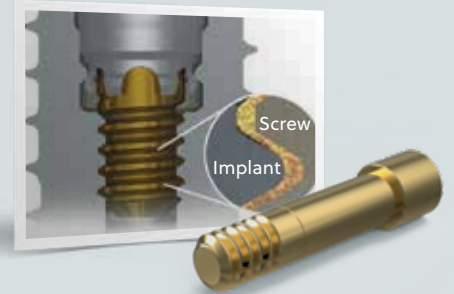
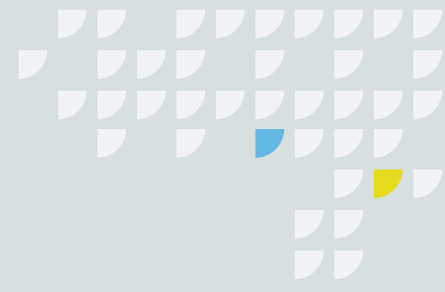

### SureSeal Technology for the Certain Implant System

- Superior seal integrity at the interface between the implant and abutment
- Combination of the proprietary Gold-Tite<sup>®</sup> Screw and Certain Internal Connection
- Minimizes abutment micromotion and reduces potential microleakage

One driver for compatible ZimVie Dental Connections



Hexalobular screwdriver is available in three different lengths (21 mm, 28 mm, 36 mm). The hexalobular design allows the universal use with all GenTek Try-In Titanium and Gold-Tite Hexalobular Screws.

### Hexalobular screwdrivers and screws

Screwdrivers now feature a hexalobular design to allow for universal use, regardless of the ZimVie Dental Implant Connection. Screwdrivers are available in three different lengths to accommodate a wide range of cases, and include an in-groove designed for dental ring placement for easy length identification.<sup>2</sup> Screws now contain a hexalobe design to be used in conjunction with the drivers.<sup>3</sup>

<sup>1</sup> Engaging Ti-Base: position of the channel is limited by the internal hex, every 30°. For multi-unit, no restrictions.  
<sup>2</sup> Silicone rings not provided and not sold by ZimVie Dental.  
<sup>3</sup> Hexalobular screws are required for the ASC solutions.  
<sup>4</sup> Binon PP. The evolution and evaluation of two interference-fit implant interfaces. Postgraduate Dent. 1996;3:3-13



# GenTek Ti-Bases and Encode® Emergence

## Compatibility with Encode Emergence Healing Abutment

Angulated Screw Channel Ti-Bases with variable collar heights for final custom restoration are designed to mimic the profile radius of Encode Emergence. Encode Emergence Technology eliminates the healing abutment and impression coping or Scan Body swapping process, while delivering soft-tissue healing with a natural emergence profile. The compatible Angulated Screw Channel Ti-Bases can be designed to match the patient's anatomy using the CAD libraries, thereby producing a natural emergence profile through the soft tissue.

Encode Emergence  
**3-in-1**  
Healing Abutment  
Impression Coping  
Scan Body



### PLACE

Place a ZimVie Dental Implant with an Encode Emergence Healing Abutment.

### HEAL AND SCAN

After tissue maturation, take a digital or traditional impression of the Encode Emergence Healing Abutment and send it to your preferred lab partner.

### DECODE AND DESIGN

The laboratory decodes<sup>1</sup> the Encode Emergence Healing Abutment on RealGUIDE<sup>®</sup> and proceeds with the CAD design.<sup>2,3</sup>



Mimic the same Encode Emergence shape all across the soft tissue

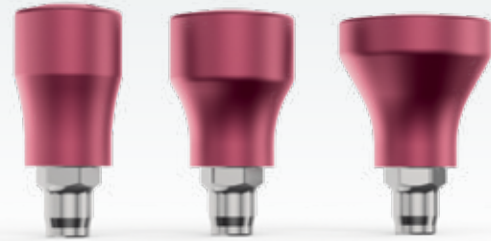
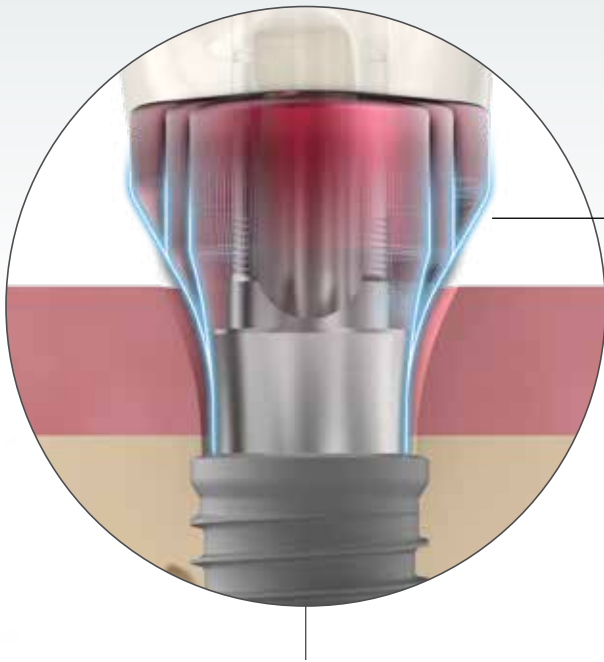

## COMPATIBLE EMERGENCE PROFILE

Download FREE Libraries for Ti-Bases and other components

RealGUIDE<sup>1</sup>  
UNIVERSAL OPEN SYSTEM

3shape<sup>2</sup> exocad

dental wings<sup>3</sup>

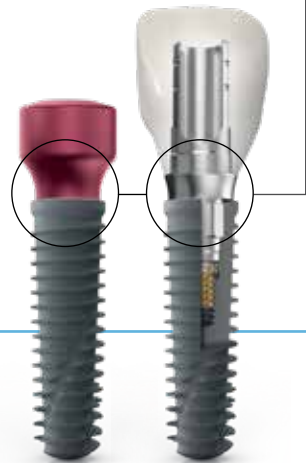

### RESTORE

Select between different GenTek consumables designed to match the patient's anatomy, producing a natural emergence profile though the soft tissue.

### SMILE

The finished prosthesis is ready to be placed. You and your patient can enjoy a precise, aesthetic result and above all, a radiant smile!

<sup>1</sup> Download the free version of RealGUIDE and decode immediately your Encode Emergence Healing Abutment  
<sup>2</sup> Patient Specific Abutment CAD design requires GenTek Library. GenTek Library can be downloaded for free on RealGUIDE, exocad, 3Shape, and Dental Wings CAD softwares.

<sup>3</sup> Duplication possible between the margin of the Ti-Base and the top of the soft-tissue for RealGUIDE CAD subscribers.



# GenTek Ti-Bases Milling Block Compatible



GenTek Ti-Bases are available with genuine connections for the following ZimVie Dental Implant Systems: Certain, External Hex, and T3 PRO. A genuine connection Ti-Base aims to provide the performance you expect through ZimVie Dental's proven SureSeal Technology when mated with a ZimVie Dental Implant.

## GenTek Ti-Base main features and benefits:

- High restorative flexibility for both screw- and cement-retained options
- Indicated for use for single-unit, multi-unit, and full-arch restorations utilizing digital or traditional workflows
- 4.7 mm in height, meeting geometrical requirements for Sirona CEREC blocks for CEREC Chairside Milling and in-lab CAD/CAM solutions
- Compatible with oxide, glass, hybrid ceramics, and PMMA providing a variety of restoration options
- Libraries for Ti-Bases and other components available for RealGUIDE!, 3Shape, exocad, and Dental Wings CAD
- GenTek branded to indicate a genuine connection. Look for the "GenTek" marking at the base of the Ti-Bases to verify authenticity

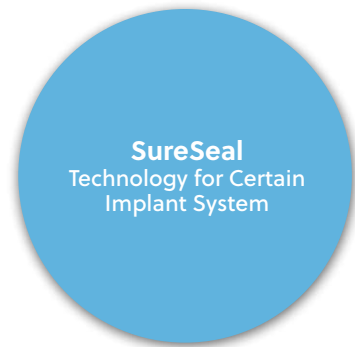

The Gluing Screw, provided with each GenTek Ti-Base, protects the screw channel from the inflow of glue into the screw channel while gluing the prosthetic restoration.

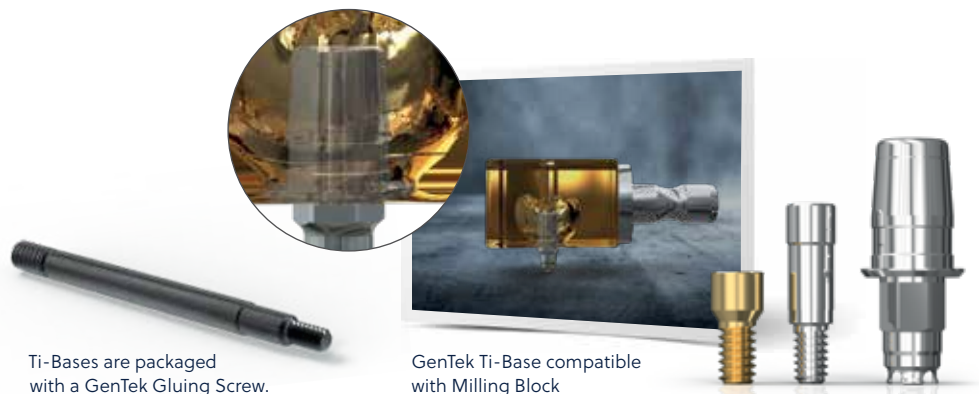

Ti-Bases are packaged with a GenTek Gluing Screw.

GenTek Ti-Base compatible with Milling Block



## Features by Ti-Base Option

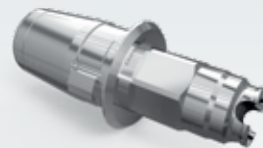

Features	GenTek Ti-Bases with Angulated Screw Channel	GenTek Ti-Bases Milling Block Compatible
Restorative Platform	T3 PRO/Certain	Certain, External Hex
Sizes	For all implant platforms <sup>3</sup>	For all implant platforms <sup>2</sup>
Angulations	Yes (up to 25°)	None
Post Height	7 mm with two cutting grooves, allows for 5.7 mm and 4.5 mm heights	4.7 mm post height with one cutting groove at 4.0 mm height
Mimics Encode Emergence Profile	Yes, 1.3 mm and 2.6 mm collar heights for T3 PRO/Certain Connection	No
Implant Connection and Multi-Unit Abutment Level Ti-Bases	Implant level connections only	Yes
Ceramic Milling Block Compatible	No	Yes
Multiple Collar Heights	Yes <sup>4</sup>	No
Gluing Screw	Yes	Yes
Original Screw	Yes	Yes
Libraries	RealGUIDE, exocad, 3Shape, Dental Wings	RealGUIDE, exocad, 3Shape, Dental Wings

## Collar Heights

Compatible Implant System	Engaging/Non-Engaging Angulated Screw Channel Ti-Base Connection	Angulated Screw Channel Ti-Base Collar Heights (mm)	Encode Emergence Profile Height Compatibility (mm)
Certain (Tapered and Parallel Walled) T3, T3 PRO	Engaging (Hexed)	0.3, 1.3, 2.6	1.3, 2.6
	Non-Engaging (Non-Hexed)	0.3, 1.3	1.3

<sup>1</sup> GenTek is currently available in RealGUIDE for prosthetic-driven surgical Planning functionality. CAD Design functionality will be available soon.

<sup>2</sup> Milling block compatible Ti-Bases for Certain, External Hex Implant Systems. 6.0 mm Ti-Base is not offered for Certain and External Hex. 5.0 mm GenTek Ti-Base can be used on a 6/5mmD Certain Implant.

<sup>3</sup> For Certain and TSV Implant Systems, 6.0 mm Ti-Base is not offered. Certain 5.0 Ti-Base can be used on a 6/5 mmD Certain Implant.

<sup>4</sup> Certain connections – 0.3 mm, 1.3 mm, and 2.6 mm.

# GenTek Titanium Pre-Milled Abutment Blanks

The GenTek Titanium Pre-Milled Abutment Blanks enable dental technicians to produce one-piece customized titanium abutments in their own laboratory without compromising connection quality and restoration performance. GenTek Titanium Pre-Milled Abutment Blanks are available for the following ZimVie Dental Implant Systems: Certain and T3 PRO.



## GenTek Titanium Pre-Milled Abutment Blanks main features and benefits:

- The blanks are pre-fabricated with genuine connections to ensure an accurate fit and superior performance with the implant connection
- Processing flexibility: Compatible with a variety of ZimVie Pre-Abutment Blank Holders and all milling machines that work with Medentika PreFace® Abutment Holders
- GenTek branded to indicate a genuine connection. Look for the "GenTek" marking at the base of the Titanium Pre-Milled Abutment Blanks to verify authenticity



The patient-specific abutment and crown can be manufactured with restorative components.



Zfx Pre-Abutment Multi-Blank Holder allows the positioning and management of up to 12 blocks.



GenTek Titanium Pre-Milled Abutment Blanks are compatible with Medentika holders. (CAM update required)

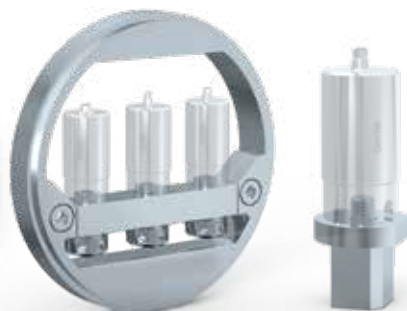

GenTek Pre-Abutment Standard Holder and Titanium Pre-Milled Abutment Adapter for GCER Holders.



# GenTek Scan Bodies and Digital Analogs

## GenTek Scan Body<sup>1</sup>

A perfect restorative design starts with a perfect scan in every CAD/CAM restoration. GenTek Scan Bodies lay the foundation for a highly precise digitization of the implant position, whether acquired with an intraoral scanner or a desktop scanner.



### The GenTek Scan Body design incorporates:

- A genuine titanium connection base to ensure a precise fit with the implant connection for optimal scanning results
- A slim asymmetric design to fit in narrow interproximal spaces
- The straight design on the titanium base of the Scan Body does not exceed the implant platform thereby mitigating the need for bone profiling when the implant is placed no deeper than 3 millimeters sub-crestal
- Dual functioning for intraoral and desktop scanning
- The body is constructed of PEEK material to provide a favorable surface for optical scanners
- The Zfx Torque Wrench is recommended for tightening the GenTek Scan Bodies when used for scanning in the lab. It features a torque control mechanism that ensures proper tightening torque on the lab model
- Requires 1.25mm hex driver



Slim design of the Scan Body is designed for tight spaces and minimizes the need for bone profiling due to the straight design.



A placement tool enables the analog to be installed with ease and accuracy.

## GenTek Digital Analogs

GenTek Digital Analogs provide an accurate fit for design of the definitive restoration. GenTek Analogs are designed with:

- A genuine connection, for a precise fit with the restorative components
- Two anti-rotation notches and a vertical stop to ensure proper orientation with reduced movement
- A snap in feature and fixation screw for analog positioning and locking all degrees of freedom
- A ZimVie color code for an easy identification of the restorative platform size

<sup>1</sup> Scan Body also referenced as Scanbody

For more information, visit [ZimVie.com](https://www.zimvie.com)

**ZimVie**

4555 Riverside Drive  
Palm Beach Gardens, FL 33410  
Phone: +1-561-776-6700  
Fax: +1-561-776-1272  
[dentalCS@ZimVie.com](mailto:dentalCS@ZimVie.com)



Unless otherwise indicated, as referenced herein, all trademarks and intellectual property rights are the property of ZimVie Inc. or an affiliate; and all products are manufactured by one or more of the dental subsidiaries of ZimVie Inc. (Biomet 3i, LLC, Zimmer Dental, Inc., Zfx GmbH, etc.) and marketed and distributed by ZimVie and its authorized marketing partners. ZimVie is an authorized distributor of iTero Products which are manufactured by Align Technology, Inc. Invisalign, iTero, iTero Element, the iTero logo, among others, are the trademarks and/or service marks of Align Technology, Inc. or one of its subsidiaries or affiliated companies and may be registered in the U.S. and/ or other countries. For additional product information, please refer to the individual product labeling or instructions for use. Product clearance and availability may be limited to certain countries/regions. This material is intended for clinicians only and does not comprise medical advice or recommendations. Distribution to any other recipient is prohibited. This material may not be copied or reprinted without the express written consent of ZimVie. Ti-Bases (Class IIb), Scan Bodies (Class I), Blanks (Class IIb), Tools (Class I), Screws (Class IIb) and Analogs (non medical devices). ZV1258 REV D 06/24 ©2024 ZimVie. All rights reserved.

